

mm MSW
Non-Contact Magnetostrictive Position Sensor

FEATURES

- Measuring length 50 to 5000 mm
- 16 bit resolution
- 0 - 10V, 0 - 20 mA, 4 - 20 mA output
- Speed information can be provided optionally.

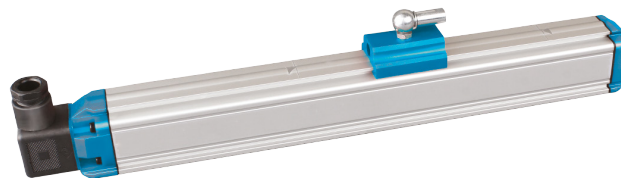

TECHNICAL SPECIFICATIONS

Measurement stroke	50 to 5000 mm
Resolution	16 bit DAC output
Linearity	50-100 mm < %1, 100-300 mm < %0.2, 300-500 mm < %0.1, 500-5000 mm > %0.05
Repeatability	±0,01% full scale
Output	0 - 10V, 10 - 0V, 0-20 mA, 20 - 0 mA, 4 - 20 mA, 20 - 4 mA (Speed information can be provided optionally.)
Power supply	24 VDC ±10%
Displacement speed	max. < 5m/s
Update time	(0-600mm, 0,5ms), (601-1500mm, 1ms), (1501-3000mm, 2ms), (3001-5000mm, 3ms)
Max. consumption	50 mA - 90 mA (depending on stroke length)
Max. output noise	< 5 mVpp
Max. output value	10,5 V
Reverse polarity protection	Up to -30 VDC
Overvoltage protection	Up to +30 VDC
Vibration	EN 60068-2-6 , 5-200 Hz / 200 m/s ² (20g) , 2h 30min each axis (x,y,z)
Shock	EN 60068-2-2:2007 / 500 m/s ² (50g) , 11ms. (x,y,z axis)
Case dimensions	33 mm x 33 mm
Case material	Anodized aluminium
Mechanical fixing	Variable brackets
Protection level	IP 67
Operating temperature	-10°C ... +70°C
Storage temperature	-30°C ... +90°C



MECHANICAL SPECIFICATIONS

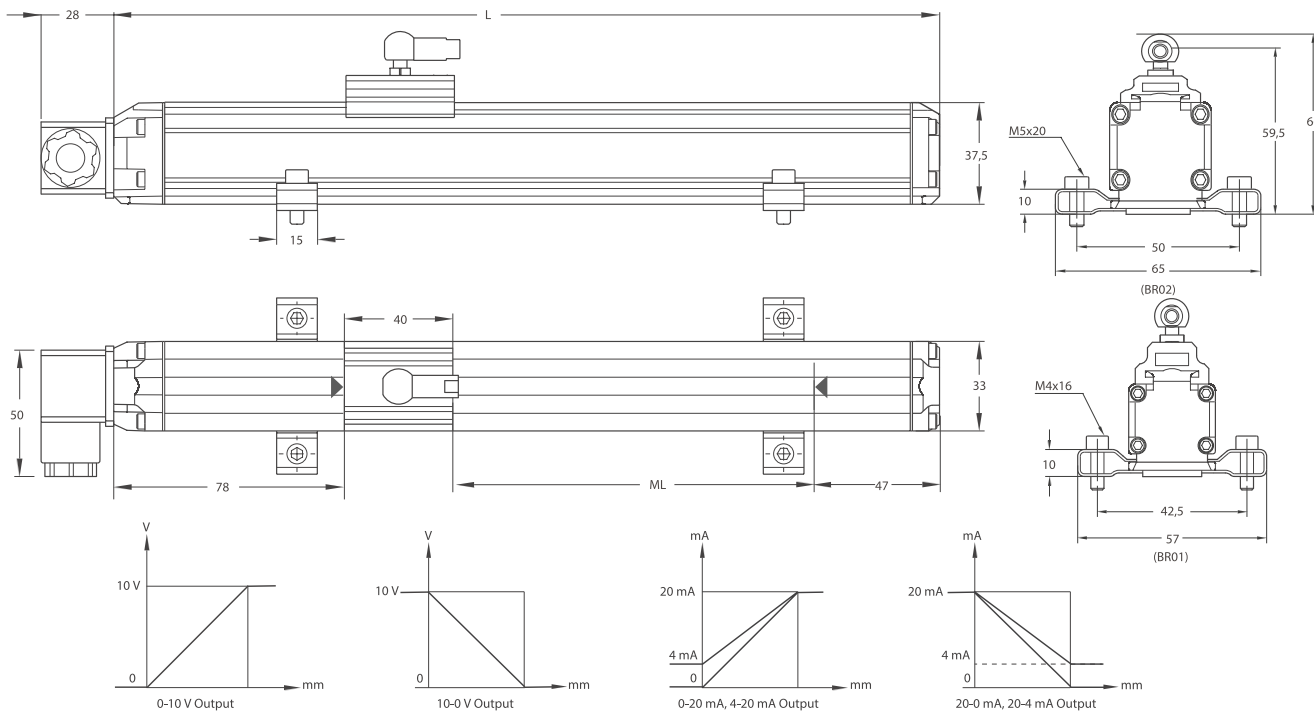

MSW (mm)	50	100	150	200	250	300	350	400	450	500	550	600	650	700	750	800	850	900	1000	1100	1200	1300	1400	1500	1750	2000	2250	2500	3000	4000	5000	
ML (Measuring Length)	50	100	150	200	250	300	350	400	450	500	550	600	650	700	750	800	850	900	1000	1100	1200	1300	1400	1500	1750	2000	2250	2500	3000	4000	5000	
(Total Length)	215	265	315	365	415	465	515	565	615	665	715	765	815	865	915	965	1015	1065	1165	1265	1365	1465	1565	1665	1915	2242	2497	2747	3277	4317	5317	
Dead Zone Calculation	78/47																															

ROUND CONNECTOR

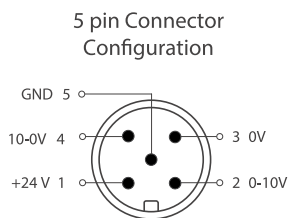

CN5 M12 (A) / M16 (B)
5 pin

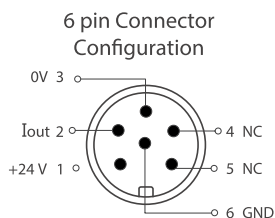

CN6 M12 (A) / M16 (B)
6 pin

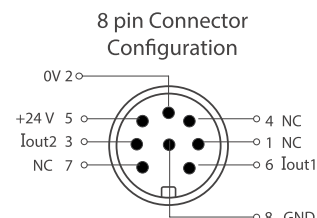

CN8 M12 (A) / M16 (B)
8 pin

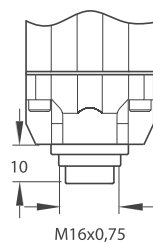
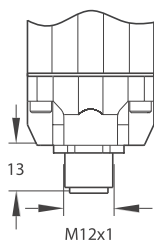



HYDRAULIC TYPE CONNECTOR

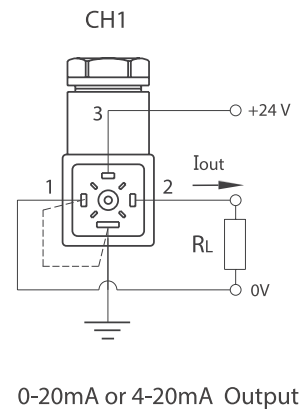
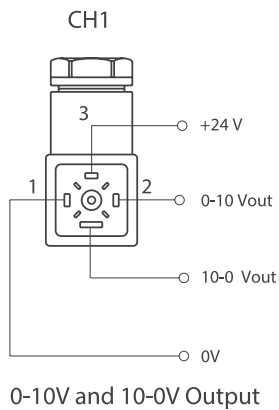
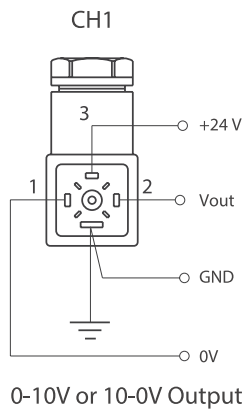

CABLE

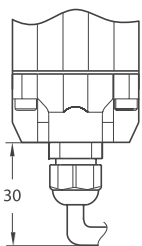

Voltage Output

- +V : Brown
- 0V : Blue
- 0V Sense : Black
- Output 1 : White (0-10V)
- Output 2 : Orange (10-0V)
- Earth : Shield

Current Output

- +V : Brown
- 0V : Blue
- 0V Sense : Black
- Output 1 : White (Iout 1)
- Output 2 : Orange (Iout 2)
- Earth : Shield

Cable Length

- 1M : 1 meter (standard)
- (Other cable lengths available)

CURSOR

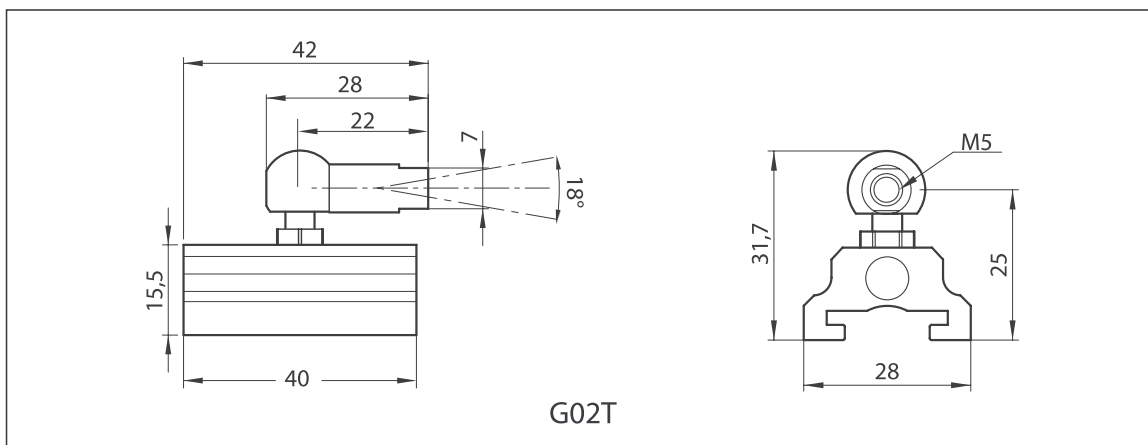



ORDERING PROCEDURE

Model	Measuring range	Resolution	Cursor	Output1	Output2(optional)	Connector / Cable	Bracket	Dead zone
MSW	300	A	1G02T	V10	Sxxx	CH1	BR02	78/47
MSW	50 - 5000mm	A: 16 bit B: 15 bit C: 14 bit D: 13 bit E: 12 bit	1G02T: 1cursor	V10 : 0-10V 2V10 : 0-10V/0-10V V01 : 10-0V 2V01 : 10-0V/10-0V V11 : 0-10V/10-0V V50 : 0-5V 2V50 : 0-5V/0-5V V05 : 5-0V 2V05 : 5-0V/5-0V V51 : 0-5V/5-0V	Sxxx S: Speed xxx: max. speed (mm/s)	CH1 : Hydraulic type CN5A : M12 CN5B : M16 CN6A : M12 CN6B : M16 CN8A : M12 CN8B : M16 1M : 1 meter 2M5 : 2.5 meter	BR01 BR02	≤ 2000 mm 78/47 > 2000-3000 mm 160/47 > 3000-4000 mm 190/47 > 4000-5000 mm 230/47

* T-coded sensors are used with T-coded cursors.

The information provided herein is to the best of our knowledge true and accurate, it is provided for guidance only. All specifications are subject to change without prior notification.

Althen – Your expert partner in Sensors & Controls | althensensors.com

Althen stands for pioneering measurement and custom sensor solutions. In addition we offer services such as calibration, design & engineering, training and renting of measurement equipment.

Germany/Austria/Switzerland
info@althen.de

Benelux
sales@althen.nl

France
info@althensensors.fr

Sweden
info@althensensors.se

USA/Canada
info@althensensors.com

Other countries
info@althensensors.com