



mm FDRF627 Series



LASER SCANNERS

USER MANUAL

Contents

1.	Safety precautions	4
2.	CE compliance	4
3.	Laser safety	4
4.	General information	4
5.	Structure and operating principle	4
6.	Configurations, operating modes, and options	5
7.	Basic technical data	6
7.1.	Specification	6
7.2.	Working ranges and dimensions	6
8.	Example of item designation when ordering	9
9.	Overall demands for mounting	9
10.	Connection	9
10.1.	Designation of connector contacts	9
10.2.	Cables	10
10.3.	Button and indication	11
11.	Ethernet interface	11
12.	Network configuration and the first connection	11
12.1.	Network configuration	11
12.2.	First connection	12
13.	Software and resources	12
14.	Web page	13
15.	Search for scanners on the network and connection	14
16.	Obtaining the image, profile and intensity	15
16.1.	"Video" tab. Image view	15
16.2.	"Viewer" tab. Data view	16
16.2.1.	Accumulation of profiles in internal memory of the scanner	19
16.2.2.	Viewing accumulated profiles	20
16.2.3.	Export of accumulated profiles	23
17.	Setting parameters	23
18.	"Network" tab. Network parameters	24
19.	"General" tab. General parameters	24
19.1.	Image quality settings	24
19.1.1.	Frame rate	25
19.1.2.	Exposure time and laser power	25
19.2.	ROI settings	26
19.3.	Data stream control	27
20.	"Profile processing" tab. Profile extraction settings	28
20.1.	"Pre Processing" section. Profile extraction parameters setting	28
20.1.1.	"Peak selection mode" parameter	29
20.1.2.	"Exposure HDR" parameter	31
20.2.	"Post Processing" section. Filtering	32
20.3.	"Dump Control" section. Building 3D models	32
21.	"Triggering settings" tab. Triggering modes	33
21.1.	Time cycle	33
21.2.	Triggering modes	34
22.	"Triggering settings" tab. Synchronization of multiple scanners	36
22.1.	Synchronous measurements	36
22.2.	Asynchronous measurements	37
23.	"System" tab	37
23.1.	Scanner name change. Log files	37
23.2.	Compatibility with RF625 scanners	38
23.3.	Firmware update	38
23.4.	Calibration table update	39
24.	"Info" tab.....	39
25.	"Log data" tab	40

26.	Maintenance	40
27.	Troubleshooting	40
28.	Annex 1. Recovery Mode	41
28.1.	"General" tab	42
28.1.1.	Scanner information	42
28.1.2.	Firmware update	42
28.2.	"Network" tab	43
28.3.	"Log data" tab	43
29.	Warranty policy	44
30.	Technical support	44
31.	Revisions	45

1. Safety precautions

- Use supply voltage and interfaces indicated in the scanner specifications.
- In connection/disconnection of cables, the scanner power must be switched off.
- Do not use scanners in locations close to powerful light sources.
- To obtain stable results, wait about 20 minutes after scanner activation to achieve uniform scanner warm-up.
- Scanners must be grounded.

2. CE compliance

Laser scanners have been developed for use in industry and meet the requirements of the following Directives:

- EU directive 2014/30/EU. Electromagnetic compatibility (EMC).
- EU directive 2011/65/EU, "RoHS" category 9.

3. Laser safety

Scanners belong to 2M laser safety class according to IEC/EN 60825-1:2014. Scanners make use of an c.w. 660 nm or 405 nm or 450 nm or 808 nm wavelength semiconductor laser. Maximum output power is 10 mW. The following warning label is placed on the scanner housing:

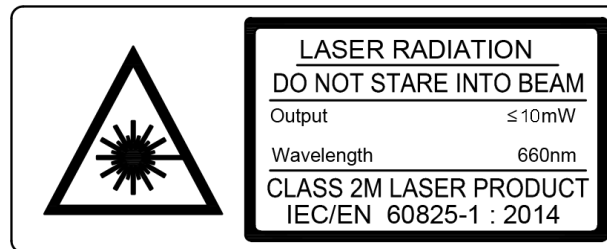

The following safety measures should be taken while operating the scanners:

- Do not target laser beam to humans.
- Do not disassemble the scanner.
- Avoid staring into the laser beam.

4. General information

Laser scanners are designed for non-contact measuring and checking of surface profile, position, displacement, dimensions, sorting and sensing of technological objects, 3D models construction.

5. Structure and operating principle

Operation of the scanners is based on the principle of optical triangulation (see Figure below).

Radiation of a semiconductor laser is formed by a lens in a line and projected to an object. Radiation scattered from the object is collected by the lens and directed to a two-dimensional CMOS image sensor. The image of object outline thus formed is analyzed by a FPGA and signal processor, which calculates the distance to the object (Z-coordinate) for each point of the set along the laser line on the object (X-coordinate). Scanners are characterized by the beginning of the range (SMR) for Z-coordinate, measuring range (MR) for Z-coordinate, measuring range for X-coordinate at the beginning of Z (Xsmr) and measuring range for X-coordinate at the end of Z (Xemr).

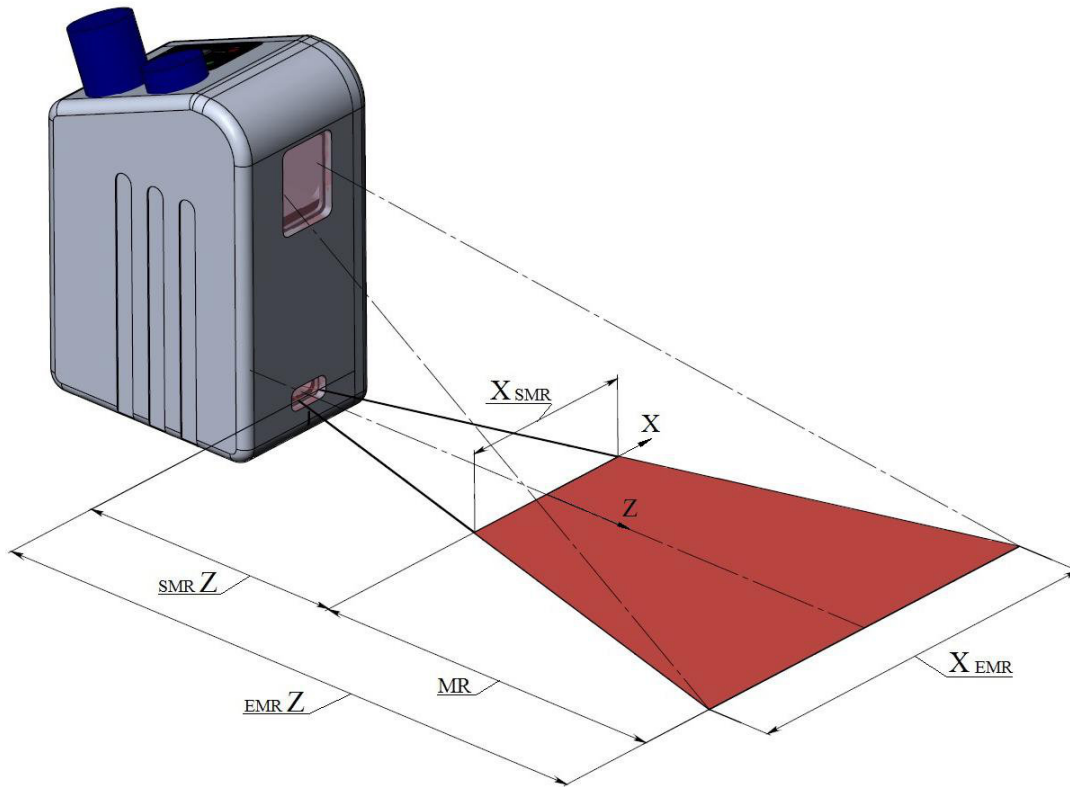

6. Configurations, operating modes, and options

Scanners are available in the following versions:

- based on red laser, 660 nm;
- based on blue lasers (BLUE version), 405 or 450 nm;
- based on infrared laser (IR version), 808 nm.

We use different lasers due to a wide range of applications. For example, the use of blue lasers instead of red ones is optimal for the control of shiny materials, high-temperature objects and organic materials.

The use of scanners with lasers of different wavelengths in one measurement system makes it possible to avoid the scanners mutual influence and greatly simplifies the system construction.

Scanners can be equipped with a built-in heater for operation under low-temperature conditions. Scanners can be equipped with a air (water) cooling system and air-knife system for windows.

There are two operating modes in the full working range: with frequencies of 484 Hz (profiles/second) and 938 Hz (**DS** mode).

In addition, you can use the ROI function, which makes it possible to increase the working frequency of the scanner in the limited working range up to 5096 Hz and up to 6800 Hz in the **DS** mode.

7. Basic technical data

7.1. Specification

Sampling rate, accuracy, resolution	
Nominal sampling rate (full working range)	484 profiles/s (standard mode), 938 profiles/s (DS mode)
Maximal sampling rate (ROI mode)	5096 profiles/s, 6800 profiles/s (DS mode)
Linearity (measurement error), Z axis	±0.05% of the range (standard mode), ±0.1% of the range (DS mode)
Linearity (measurement error), Xaxis	±0.2% of the range
Resolution, Z axis	0.01% of the range (standard mode), 0.02% of the range (DS mode)
Resolution, Xaxis	648 or 1296 points (programmable value)
Laser	
660 nm or 405 nm or 450 nm or 808 nm Class 2M according to IEC/EN 60825-1:2014	
Interface	
Basic	Ethernet / 1000 Mbps
Synchronization inputs	RS422, 3 channels
Laser on/off hardware input	1
Outputs	RS422, 1 channel
Power supply	9...30 V or 12...39 V for scanners with Blue laser
Power consumption, not more	6 W (without a built-in heater)
Environmental resistance	
Enclosure rating	IP67
Vibration	20 g / 10...1000 Hz, 6 hours for each of XYZ axes
Shock	30 g / 6 ms
Operating ambient temperature	-20...+40°C, or -40...+40°C for scanners with built-in heater, or -40...+120°C for scanners with built-in heater and cooling system
Storage temperature	-20...+70°C
Relative humidity	5-95% (no condensation)
Housing/windows material	aluminum/glass

7.2. Working ranges and dimensions

Range	MR, mm	SMR, mm	EMR, mm	Xsmr, mm	Xemr, mm	Size, mm	Weight, g
25/10-8/11	10	25	35	8	11	Figure 1	0.37
65/25-20/22	25	65	90	20	22	Figure 2	0.6
75/50-30/41	50	75	125	30	41		
70/100-48/82	100	70	170	48	82		
70/150-58/122	150	70	220	58	122		
95/150-53/106	150	95	245	53	106		
82/200-60/150	200	82	282	60	150		
90/250-65/180	250	90	340	65	180		
180/250-170/278	250	180	430	170	278	Figure 3	L=326 mm 2
190/300-160/300	300	190	490	160	300		L=283 mm 1.9

220/300-203/330	300	220	520	203	330	L=374 mm	2.1
260/400-210/400	400	260	660	210	400	L=350 mm	2.2
325/500-268/500	500	325	825	268	500	L=415 mm	2.3
400/600-320/600	600	400	1000	320	600	L=490 mm	2.4
475/700-374/700	700	475	1175	374	700	L=558 mm	2.5
545/800-425/800	800	545	1345	425	800	L=627 mm	2.6
615/900-480/900	900	615	1515	480	900	L=696 mm	2.7
690/1000-535/1000	1000	690	1690	535	1000	L=765 mm	2.8
620/1165-430/1010	1165	620	1785	430	1010	L=554 mm	2.5

Detailed CAD documentation (2D and 3D) is available here:

https://riftek.com/media/documents/RF627/CAD/2D_CAD.rar

https://riftek.com/media/documents/RF627/CAD/3D_CAD.rar

The scanner housing is made of anodized aluminum. The front panel of the housing has two windows: the output window and the window for receiving radiation reflected from the object under control. Overall and mounting dimensions of the scanners are shown in the Figures below. The housing has fastening holes for installing the scanner on the equipment. The sensors, shown in Figure 3, are equipped with an adjustable support that allows you to implement three options for mounting the scanner.

The scanner has two connectors, **Reset** button, and LED indicators.

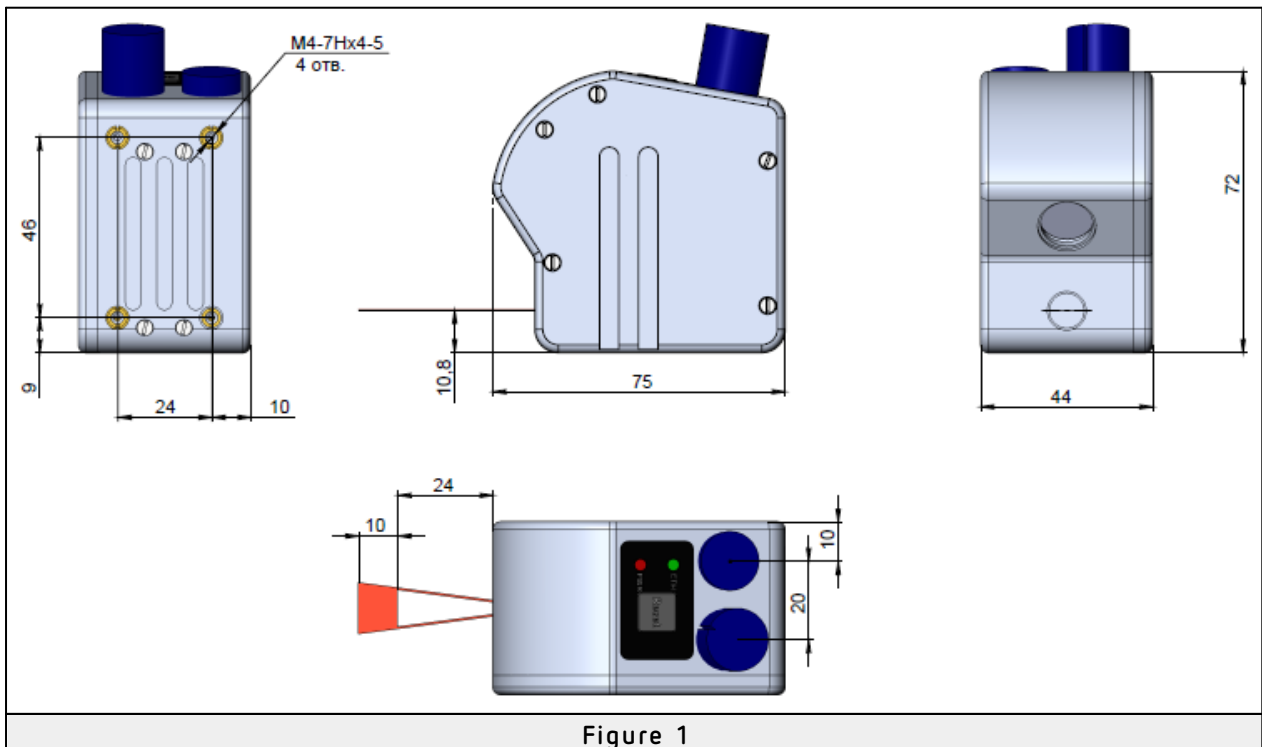

Figure 1

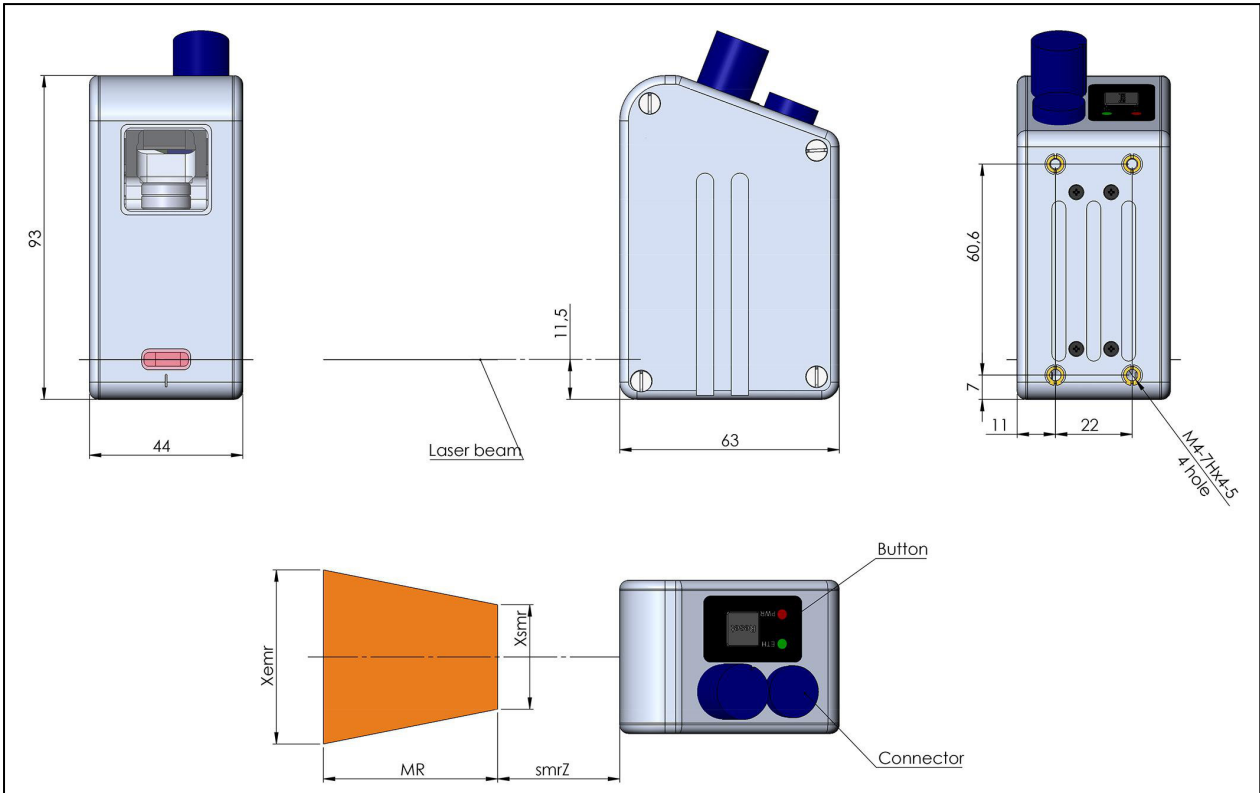

Figure 2

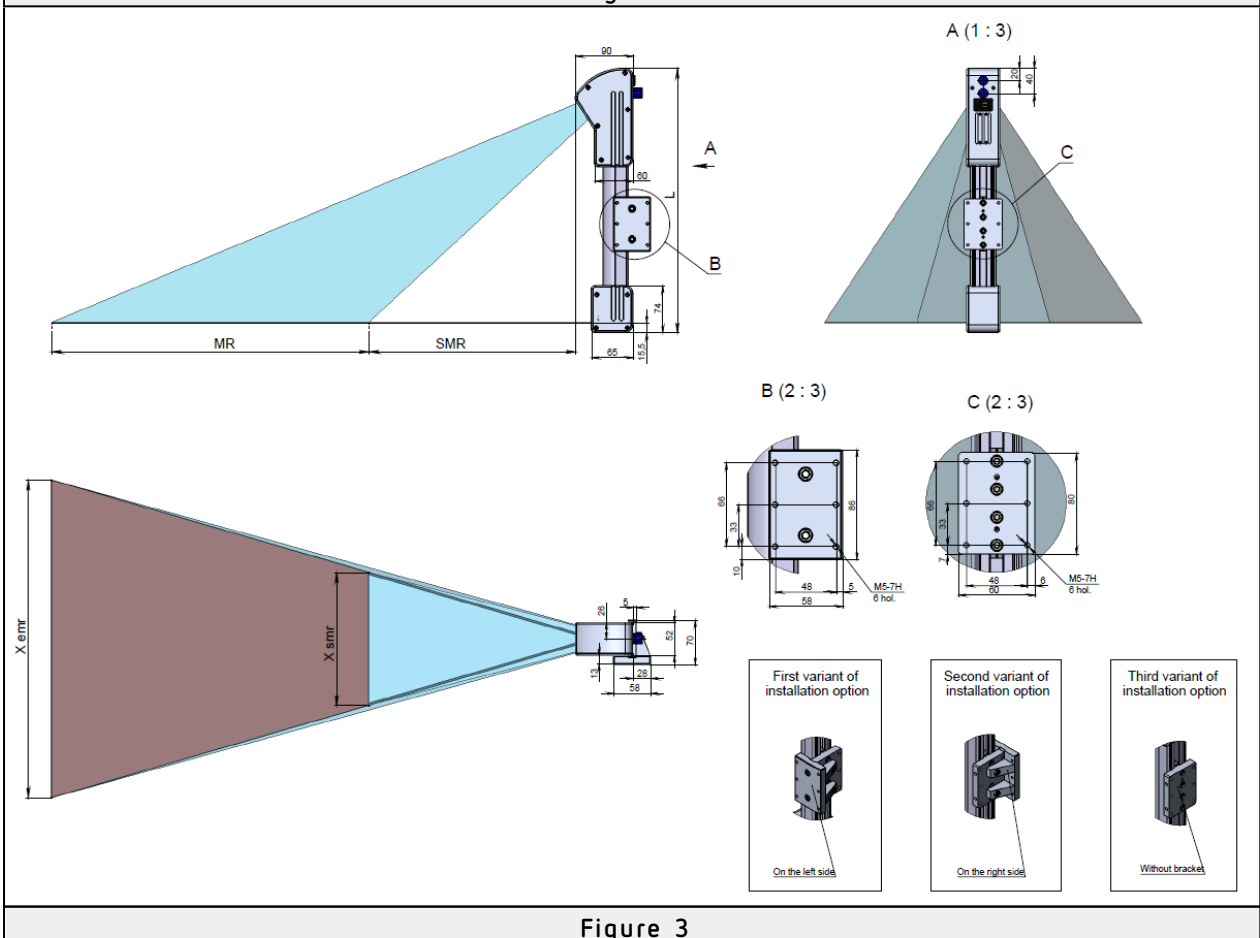

Figure 3

8. Example of item designation when ordering

FDRF627.(WAVE)-SMR/MR-Xsmr/Xemr-M(R)-H--AK-EW-AC

Symbol	Description
(WAVE)	Laser wavelength. 660 nm - no symbol, 405 nm or 450 nm - BLUE, 808 nm - IR.
SMR	Beginning of the measuring range for Z, mm.
MR	Measuring range for Z, mm.
Xsmr	Measuring range for X-coordinate at the beginning of the measuring range for Z-coordinate, mm.
Xemr	Measuring range for X-coordinate at the end of the measuring range for Z-coordinate, mm.
M	Cable length, m.
R	Option, robot-cable.
H	Built-in heater.
AK	Air knife for windows.
EW	Removable protective windows option.
AC	Built-in air cooling system. Ordering a water cooling system requires consultation with the manufacturer.

Example. FDRF627BLUE-70/50-30/42-5 – Scanner with a blue laser, SMR - 70 mm, MR - 50 mm, Xsmr - 30 mm, Xemr - 42 mm, cable length - 5 m.

9. Overall demands for mounting

The scanner should be positioned so that the object under control has to be placed within the working range of the scanner. In addition, no foreign objects should be allowed to stay on the path of the incident and reflected laser radiation.

Where objects to be controlled have intricate shapes and textures, the incidence of mirror component of the reflected radiation to the receiving window should be minimized.



ATTENTION!

The scanner must be grounded. Static electricity may cause the failure of electronic components.

10. Connection

The scanner is shipped with two cables:

- 1) Ethernet cable;
- 2) Power cable with synchronization lines and outputs.

10.1. Designation of connector contacts

The scanner is equipped with two connectors:

1. Ethernet connector.
2. Multi-connector.

View from the side of connector contacts is shown below:

Connector 1 (Binder 712 Series, #09-0427-80-08)	Connector 2 (SACC-DSI-M12MS-12CON-M12)

Designation of contacts is given in the tables below.

Connector 1:

#	Assignment, 100baseTX	Assignment, 1000baseT
1		D4+
2		D3-
3		D3+
4	RX-	D2-
5	RX+	D2+
6	TX-	D1-
7	TX+	D1+
8		D4-

Connector 2:

#	Assignment	Note
1	OUT1-	RS422
2	IN3-	RS422
3	IN3+	RS422
4	IN2-	RS422
5	IN2+	RS422
6	NEXT_LAS_OFF	Laser OFF
7	IN1+	RS422
8	IN1-	RS422
9	OUT1+	RS422
10	V+	+9...30V, 650mA max
11	GND	Grounding
12	0V	0V power supply («-»)

10.2. Cables

Cable #1:

Pin number, RJ45	Assignment, 100baseTX	Assignment, 1000baseT	Wire color
1	TX+	D1+	White/orange
2	TX-	D1-	Orange
3	RX+	D2+	White/green
4		D3+	Blue
5		D3-	White/blue
6	RX-	D2-	Green
7		D4+	White/brown
8		D4-	Brown

Cable #2, free leads:

Wire color	Description
Black	OUT1-
Gray/pink	IN3-
Red/blue	IN3+
Gray	IN2-
Pink	IN2+

White	NEXT_LAS_OFF
Green	IN1+
Yellow	IN1-
Violet	OUT1+
Red	VIN
Blue	GND
Brown	0V

10.3. Button and indication

To reboot the scanner, press the **Reset** button for 5 seconds. If you press the **Reset** button for 1 second, a broadcast Hello packet will be sent.

Red LED - the firmware is loading, green LED - the Ethernet connection is established.

11. Ethernet interface

Profiles are transmitted via the UDP protocol, the structure of packets is described in the Programmer's Guide. Download link:

https://riftek.com/media/documents/RF627/RF627_SDK_and_Service_Protocol_eng.pdf

The scanner can be controlled by the service protocol described in the Programmer's Guide, or via the WEB interface built into the scanner.

12. Network configuration and the first connection

12.1. Network configuration

All scanners are shipped with the following network configuration unless otherwise specified in the order:

- Auto negotiation of connection speed (100/1000 Mbps)
- IP address of the scanner: 192.168.1.30
- Subnet mask: 255.255.255.0
- Gateway: 192.168.1.1
- Host IP address (device that receives profiles): 192.168.1.2
- Host port that receives data: 50001
- HTTP connection port (for connecting a browser): 80
- Service port of the scanner: 50011

Since the laser scanner is configured to work in the 192.168.1.* addressspace, configure the network card of your PC, for example, as follows:

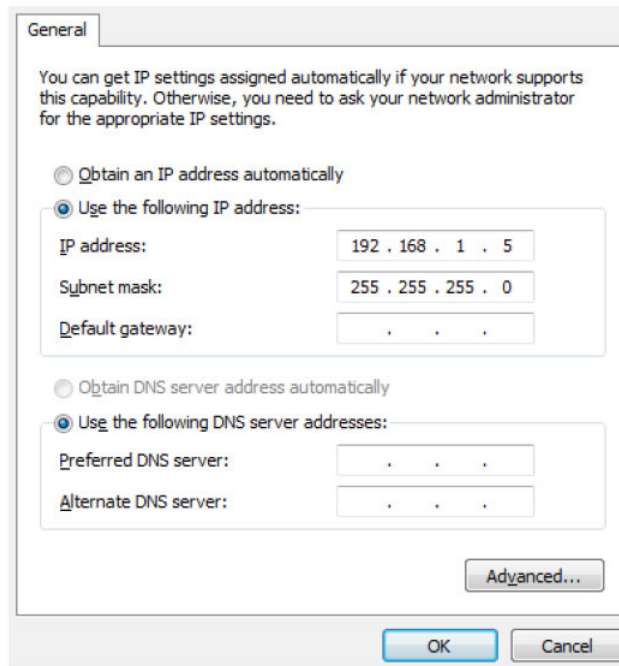

The network settings of the scanner can be changed using the service software (SDK), the service protocol, or via the web page of the scanner.

NOTE: Ethernet Jumbo frames are not supported.

12.2. First connection

- Perform the network configuration in accordance with the previous paragraph.
- Connect the scanner to the PC or to the network switch.
- Connect the power supply (9...30V) to the scanner (cable #2, a red wire is "plus" of the power supply, a brown wire is "minus").

Within 8 seconds after powering on, the FPGA firmware is booting and the Ethernet interface is initializing (the red LED blinks).

Next, it is recommended to check the connection using the console command "ping 192.168.1.30 (or the current IP address of the scanner)". If all the settings are correct, the scanner will respond to the command. A typical result is shown below:

```
Администратор: C:\windows\system32\cmd.exe
C: >ping 192.168.1.30
Обмен пакетами с 192.168.1.30 по 32 байтами данных:
Ответ от 192.168.1.30: число байт=32 время<1мс TTL=255
Ответ от 192.168.1.30: число байт=32 время<1мс TTL=255
Ответ от 192.168.1.30: число байт=32 время<1мс TTL=255
Ответ от 192.168.1.30: число байт=32 время<1мс TTL=255

Статистика Ping для 192.168.1.30:
    Пакетов: отправлено = 4, получено = 4, потеряно = 0
    <В% потерь>
    Приблизительное время приема-передачи в мс:
    Минимальное = 0мсек, Максимальное = 0 мсек, Среднее = 0 мсек
C:\Users\ >
```

The scanner is ready to operate.

To turn off the scanner, turn off the power supply.

13. Software and resources

The scanner comes with a software package, which is also available on the RIFTEK's web site.

The package includes software tools that allow to implement two ways of working with the scanner:

1. Via the web page (see par. 14.).
2. Via the software developed by the customer using the provided SDK (Software Development Kit). FDRF627 SDK includes the detailed description of all functions of the library and the examples of programs in different languages (C++, C#) ported to various platforms (Windows, Linux, .NET), and also the examples of using the libraries in different environments (MATLAB, LABVIEW). See the Programmer's Guide (the download link is given in par. 11.).

14. Web page

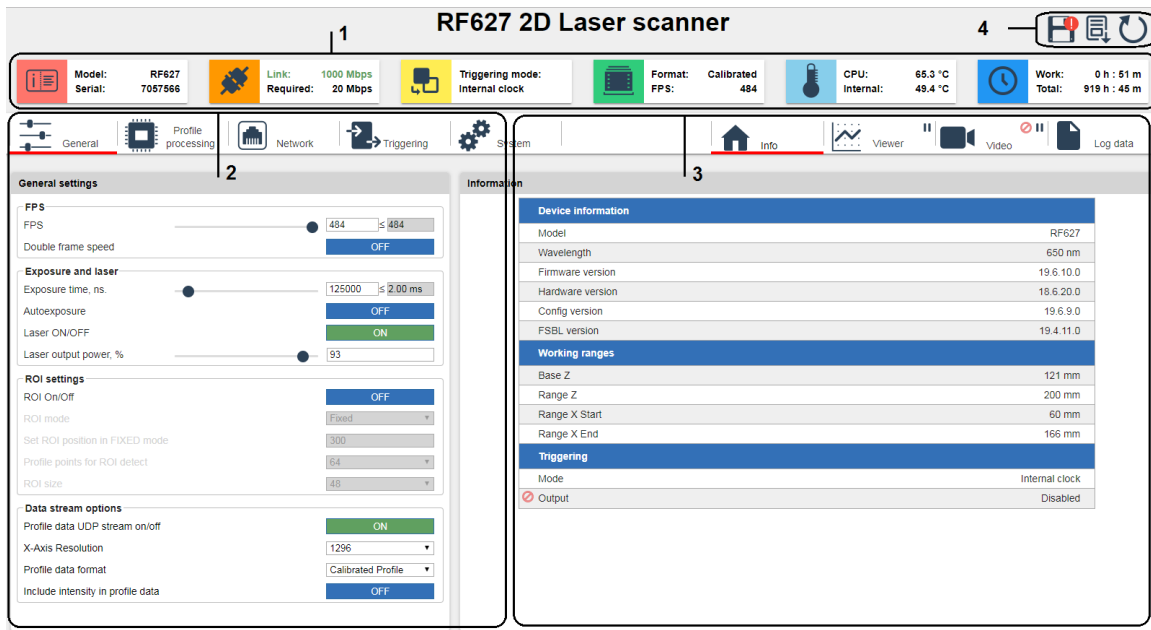

The web page is intended to check the operation and configure parameters of the scanner. To access the web page, enter the IP address of the scanner into the address bar of the web browser:





The web page contains four areas (shown above):

1. Scanner status indicators.
2. Parameterization tabs.
3. Result and status display tabs.
4. Control buttons.

Area 1 contains the following indicators:

Icon	Name	Description
	Device info	Model name and serial number of the scanner. Serial number is a unique identifier of the scanner and is assigned by the manufacturer.
	Connection status	The status of connection with the scanner. If the connection is established, the Link caption and the connection speed value will be displayed in this field. The Required caption displays the recommended connection speed required for correct operation of the device. The recommended speed depends on the operation mode of the scanner. If communication with the scanner is lost (for example, when the scanner is restarted or the connection is broken), the web page will be displayed, but the connection status will change to Disconnected .
	Triggering mode	Measurement triggering mode, in which the scanner is operating now. See par. 21 .

Icon	Name	Description
	Profile settings	The current profile data format (Format) and the current number of profiles per second (FPS) sent by the scanner via the UDP protocol. The value may vary depending on the operating mode of the scanner and its settings.
	Temperature °C	Processor temperature (CPU) and internal temperature of the scanner (Internal) in °C. This information is used to assess the operating conditions of the scanner. Do not allow the temperature to rise to 90°C or more. When the permissible temperature is exceeded, the indicator starts blinking.
	Total work time	Operating time after switching on (Work) and total operating time of the scanner (Total).





Area 2 contains the following tabs:

- **General.** General scanner settings, including parameters of CMOS-sensor and data streams.
- **Profile processing.** Profile processing settings and control of profiles accumulation in scanner memory.
- **Network.** Network settings of the scanner.
- **Triggering.** Settings of input channels of the scanner (triggering modes) and output channel for synchronization of work of several scanners.
- **System.** System settings of the scanner, including support for compatibility modes, etc.

Area 3 contains the following tabs:

- **Info.** General information about the scanner (firmware version, working range, etc).
- **Viewer.** Viewing the current profile, or viewing profiles accumulated in internal memory with the ability to display as a 3D point cloud, or viewing the intensity image.
- **Video.** Video signal view.
- **Log data.** Information about the scanner operation.

Area 4 is located in the upper right corner and contains the control buttons:

Button	Name	Description
	Save configuration	Save settings to the flash memory of the scanner.
		The exclamation mark means that the parameters have been changed, but haven't been saved.
	Load defaults	Restore the factory settings. Important: It is necessary to restart the scanner after restoring the factory settings. Click the Restart device button.
	Restart device	Restart the scanner.

15. Search for scanners on the network and connection

Enter the IP address of the scanner into the address bar of the web browser and press the **Enter** key. If the scanner is on the network, the browser will display its web page.

If all the settings are correct and the entered IP address is the IP address of the scanner, the **Status** field will show **Connected**. The scanner is ready to operate.

16. Obtaining the image, profile and intensity



The scanner can transmit:



- the image of the laser line on the object surface, and / or
- uncalibrated profile extracted from the image, or
- calibrated profile (profile in Cartesian coordinates of the scanner)
- profiles accumulated in internal memory in two modes:
 - two-dimensional profile
 - three-dimensional point cloud
- 3D intensity image

Profile and image view modes are used when configuring parameters of the scanner.

16.1. "Video" tab. Image view

To view the image, place an object within the working range of the scanner, go to the **Video** tab, and click **Play** ▶.

The  and  icons mean that you cannot / can simultaneously view an uncalibrated profile (see **Data stream options** in the **General** tab). The image transmission rate is about 10 frames/second.

To zoom in/out the image, rotate the mouse wheel or use the buttons    located in the upper right corner of the window. Returning the image to the original size is done by double-clicking in the image area.

To move the image, hold down the left mouse key and drag the image to the required position. You can save the image of the current frame. To do this, right-click in the image area and select "Save image as ..." and then specify the image name (image format is .png).

The image is displayed on two screens. On a small screen, the yellow rectangle shows the position of the viewing area:

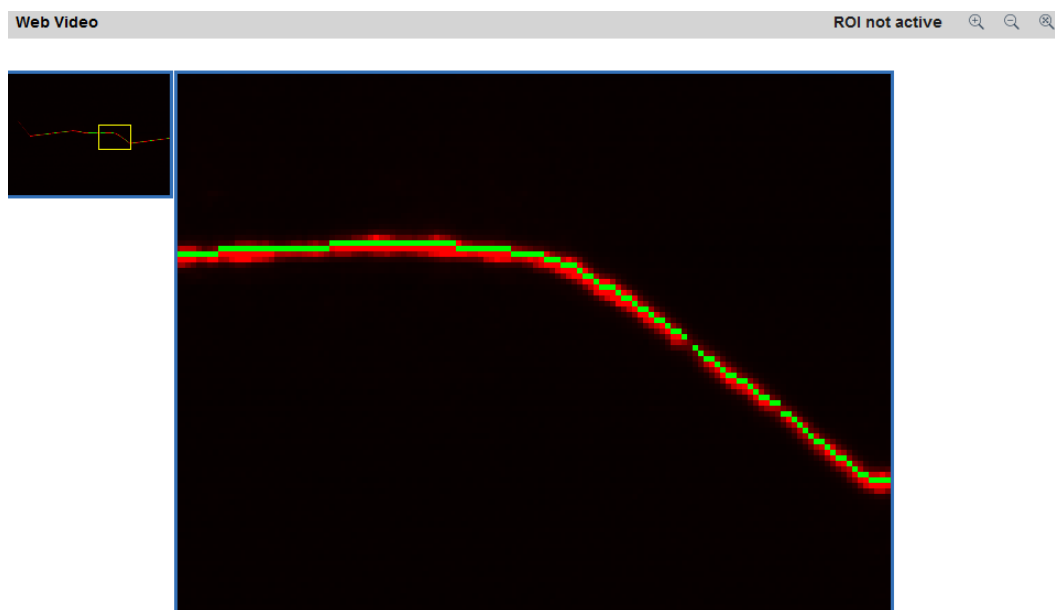

In the example above, the image was zoomed in and the  mode is enabled. Red color indicates a video signal, green color indicates an uncalibrated profile. When viewing the image in the calibrated profile mode, only the video signal is displayed.

16.2. "Viewer" tab. Data view

The **Viewer** tab is intended to visualize the data received from the scanner.

This tab allows you to view:

- currently registered profile in real-time mode;
- profiles accumulated in internal memory in two modes:
 - two-dimensional profile;
 - three-dimensional point cloud.
- 3D intensity image.

To view the current profile in real-time mode, use the icons **Play** ▶ and **Pause** ||, which are located in the **Viewer** tab.

The **Viewer** window is divided into the following areas:

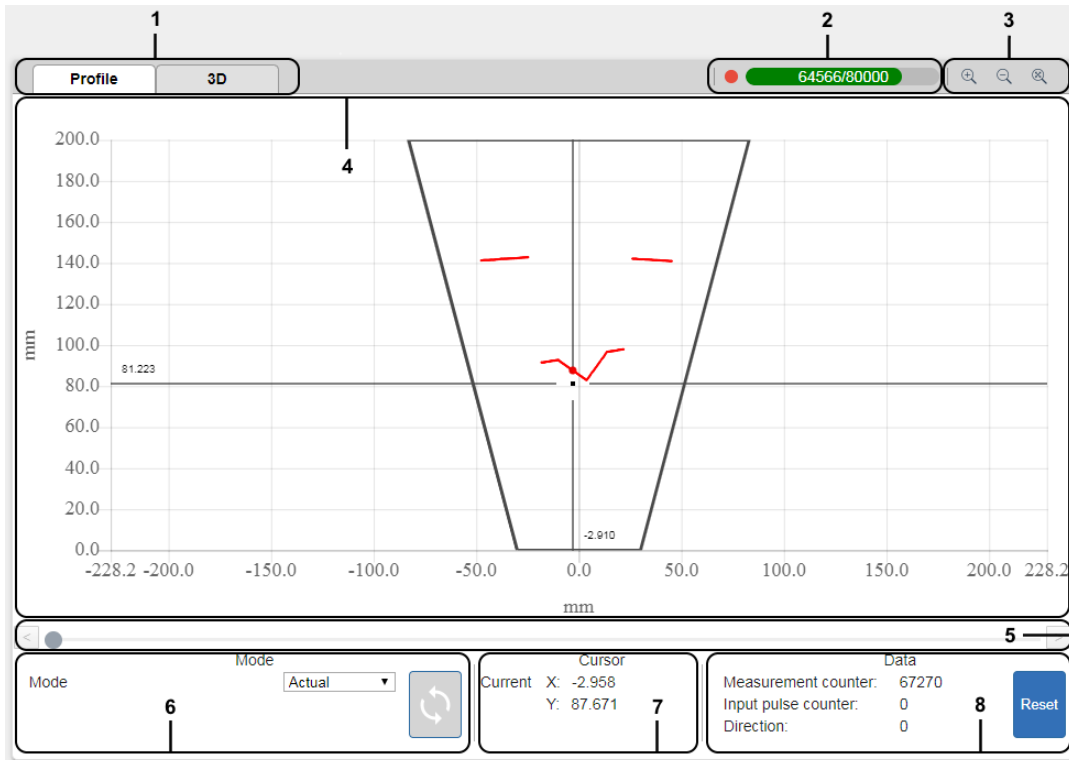

1 - Switching between viewing options.





The **Profile** tab displays a two-dimensional profile on a grid.

The **3D** tab is intended to display the current profile, or a 3D point cloud from profiles accumulated in internal memory on a three-dimensional scene, or a intensity image of a scanned object.

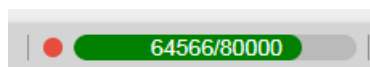
2 - Managing the accumulation of profiles in internal memory.



This area contains a button  intended to start recording profiles (it will be replaced by a stop button  during recording), and an indicator of the internal memory free space, which displays the number of accumulated profiles and the maximum possible number of profiles for accumulation.

3 - Zooming.



- zoom in, - zoom out.

To restore the original scale, use the button or double-click the left mouse key in the viewing area in the **Profile** tab.

In addition, you can rotate the mouse wheel to zoom in / zoom out the image.

4 - Viewing area.

The viewing area in the **Profile** tab contains a coordinate grid. The vertical axis corresponds to the Z coordinate of the scanner, the horizontal axis corresponds to the X coordinate of the scanner. This grid displays the profile (1), the scanner range (2) and the ROI area (3) (if ROI mode is enabled). When you hover the mouse over the selected area of the grid, a cursor appears indicating the position in the scanner coordinates. Moving an image is done with the mouse while holding down the left key.

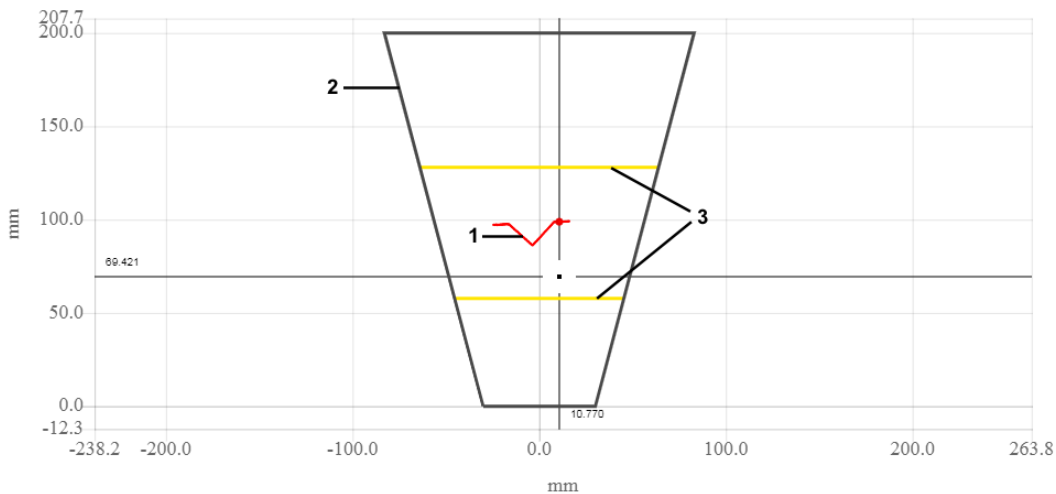

In **Raw data** mode (**General** tab > **Data stream options** section > **Profile Data Format**), an uncalibrated profile is displayed on the grid. The pixel dimension of the coordinate grid is **px**.

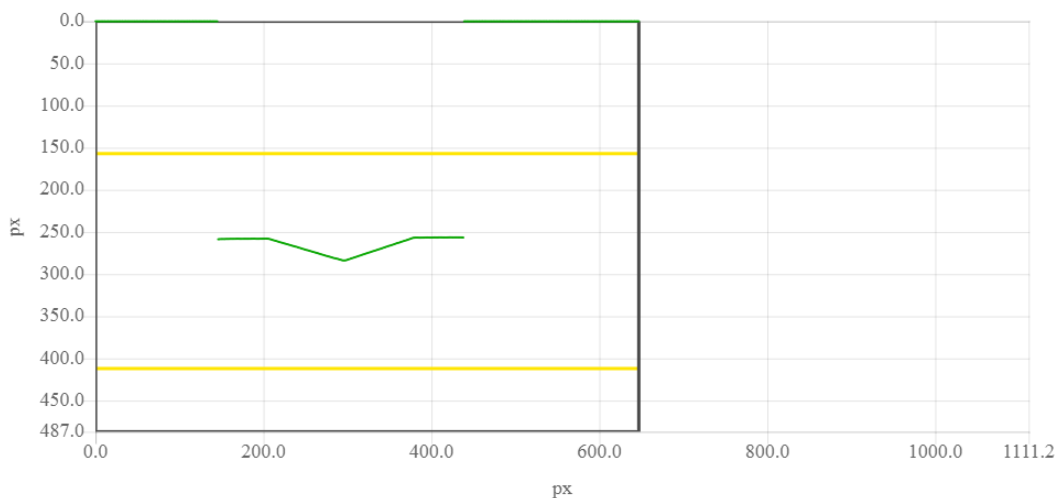

When you select the **3D** tab, a three-dimensional scene will be placed in the viewing area, which will display either the current profile (in **Actual** mode) or a 3D point cloud formed from the profiles accumulated in memory (in **Dump** mode) or the intensity image.

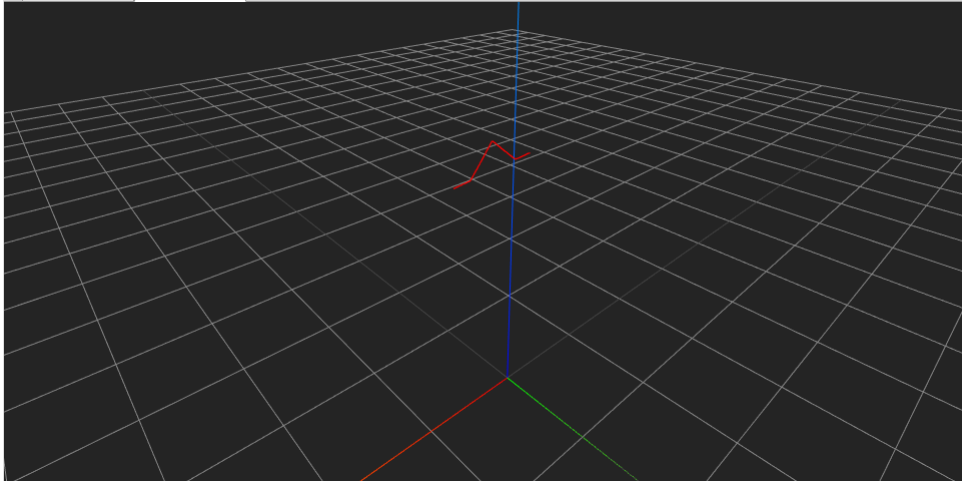

Current profile

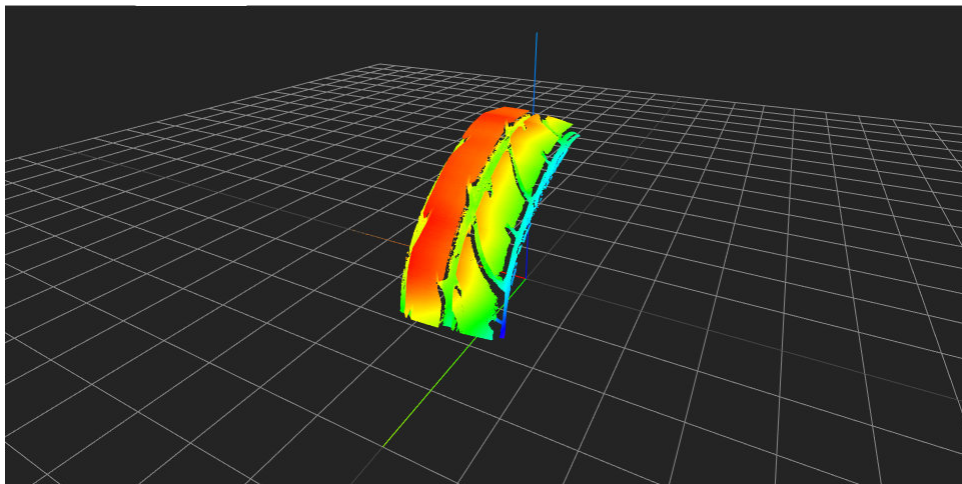



Point cloud

To rotate the camera on a three-dimensional scene, use the left mouse key. To move the scene in horizontal, use the right mouse key. Zooming is done by the mouse wheel.

5. Scroll bar.



This area is active in **Dump** mode. Moving the slider determines the profile you are viewing. The button  calls the previous profile relative to the position of the slider, and the button  calls the next profile.

6. Selecting the view mode.

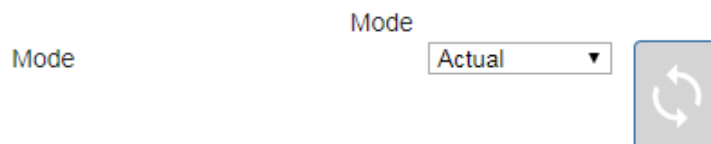

There are two modes:

- **Actual**- The viewing area displays the profile currently registered by the scanner in real time.
- **Dump**- The viewing area displays either the selected profile, or a 3D point cloud formed from the profiles accumulated in internal memory.

7. The coordinates of the profile point near the cursor.

Cursor	
Current X:	12.128
Y:	151.282



This area displays the coordinates of the profile point that is most closely located to the vertical line of the cursor.

8. Parameters of the displayed profile.

Data		Reset
Measurement counter:	591741	
Input pulse counter:	0	
Direction:	0	

This area displays the values of the **Measurements counter** and the **Inputs pulse counter**, as well as the direction of movement (rotation) along the **Direction** encoder (the description of the counters is given in the Programmer's Guide). The **Reset** button resets both counters.

16.2.1. Accumulation of profiles in internal memory of the scanner

To start recording profiles to the scanner memory, click the button  in Area 2 (see previous paragraph). After that, each profile will be stored in the internal memory of the scanner. The maximum number of profiles for recording is 80000. Recording is possible only in the **Calibrated Profile** format, otherwise the start button will be locked . During recording, you cannot change the data format and the **Data stream options** section will not be available.

NOTE: The accumulation of profiles is carried out in accordance with the selected Triggering mode (see par. [21](#)).

During recording, it is also possible to view the resulting point cloud in real time. To do this, you must first configure the settings for displaying a point cloud (see par. [20.3](#)). During recording, profiles are displayed with decimation and without coloring by height (all red).

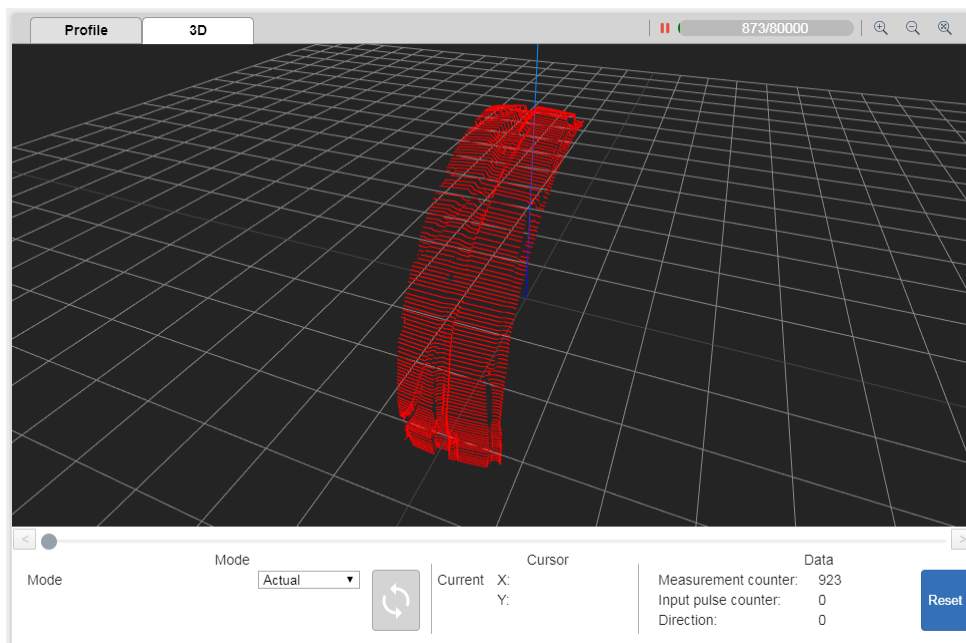

After the accumulation process is completed in the view mode, all profiles (without decimation) will be displayed after clicking on the refresh button .

16.2.2. Viewing accumulated profiles

To view the accumulated profiles, you must select the **Dump** mode in Area 6 (Selecting the view mode).

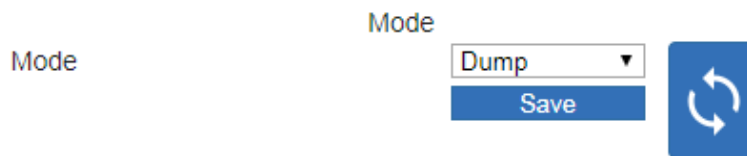

When the **Profile** tab is selected in **Dump** mode, the selected profile from those accumulated in the internal memory will be displayed on the coordinate grid.

When the **3D** tab is selected in **Dump** mode, the accumulated profiles in the form of a three-dimensional point cloud will be displayed on the three-dimensional scene. You must first configure the display settings in the **Dump control** section (see par. 20.3):

- Select the type of displacement system when receiving a point cloud.
- Specify the step between measurements (linear in mm for the **Linear** type, and angular in degrees for the **Radial** type).
- Select the selector, which is used to build the point cloud (**Measurement** and **Step** counters or **Time** profile time stamp). The step value is multiplied by the value of the parameter selected by the selector.
- Select **Coloring mode**.

After configuring the display parameters, it is necessary to click on the refresh

button  (available only in **Dump** mode). After that, the data will be downloaded from the scanner and a point cloud will appear.

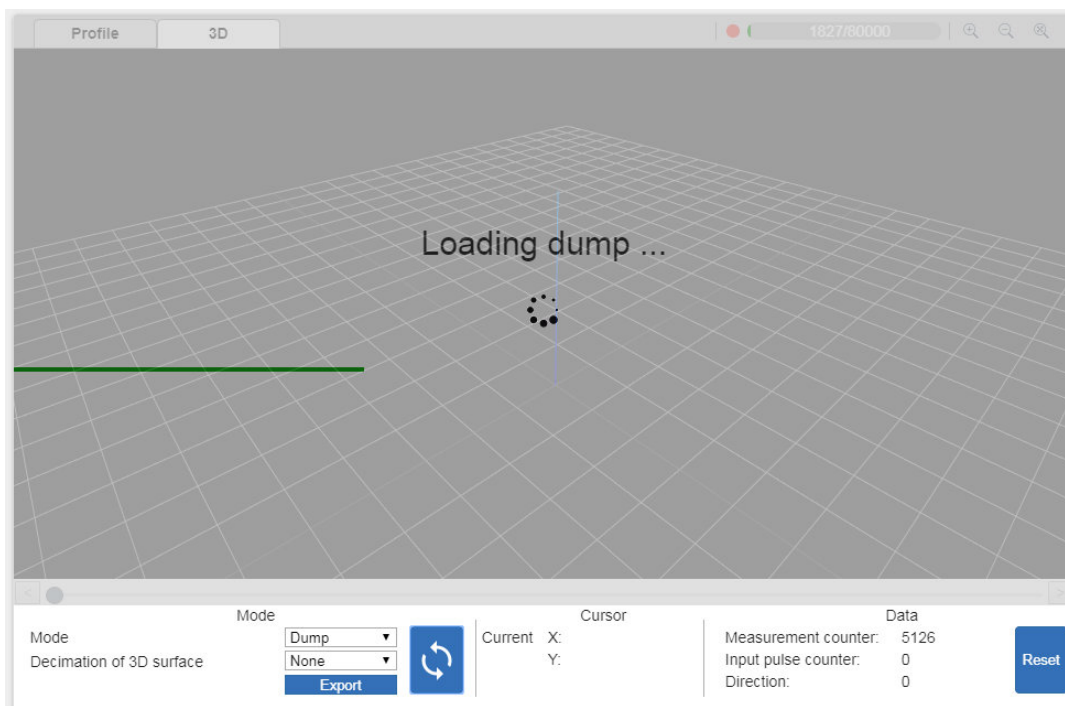

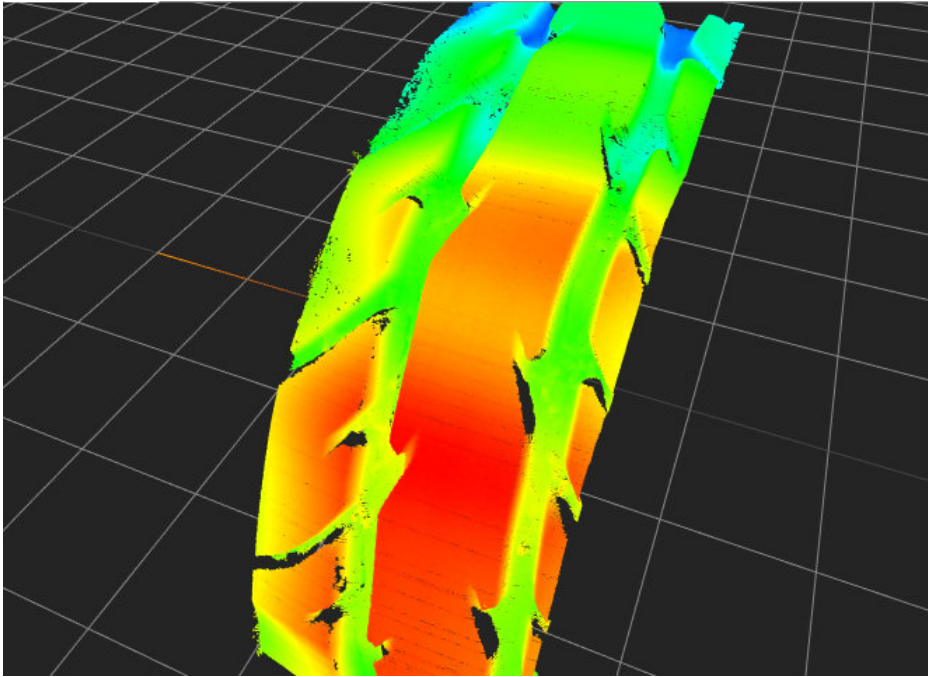

After changing any parameters in the **Dump Control** section, you must click the refresh button to redraw the point cloud with new parameters.

NOTE: To view a three-dimensional point cloud, you must have a video card of the appropriate level in your computer. To view a point cloud on weak computers, adjust the decimation of the point cloud. To do this, select the appropriate coefficient in the **Decimation of 3D surface** drop-down list.

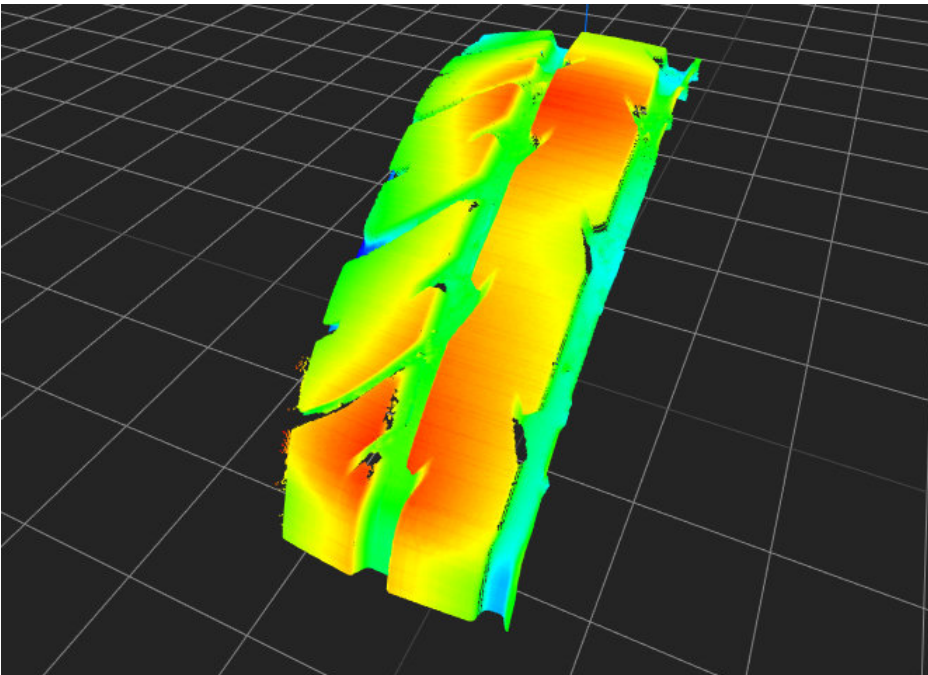

Point cloud without decimation

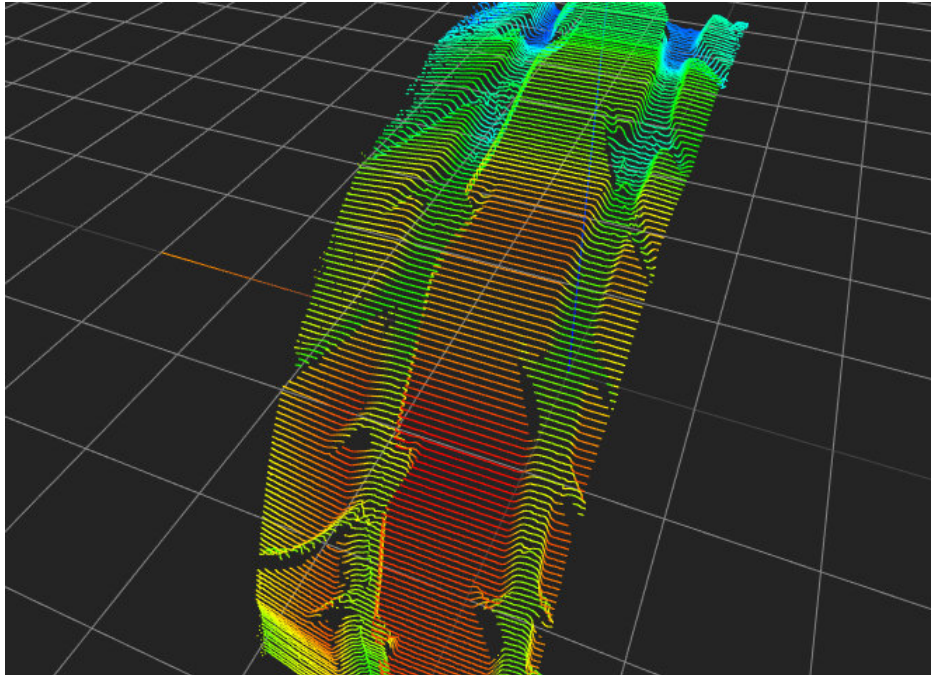

Point cloud (decimation coefficient is set to 5)

To view a point cloud with coloring by intensity, you must select the **Intensity** mode for the **Coloring mode** parameter.

NOTE: Coloring by intensity is possible only if, during recording, the brightness values were included in the profile package (see p. [19.3](#)). Otherwise, the brightness of all points will be zero (black color).

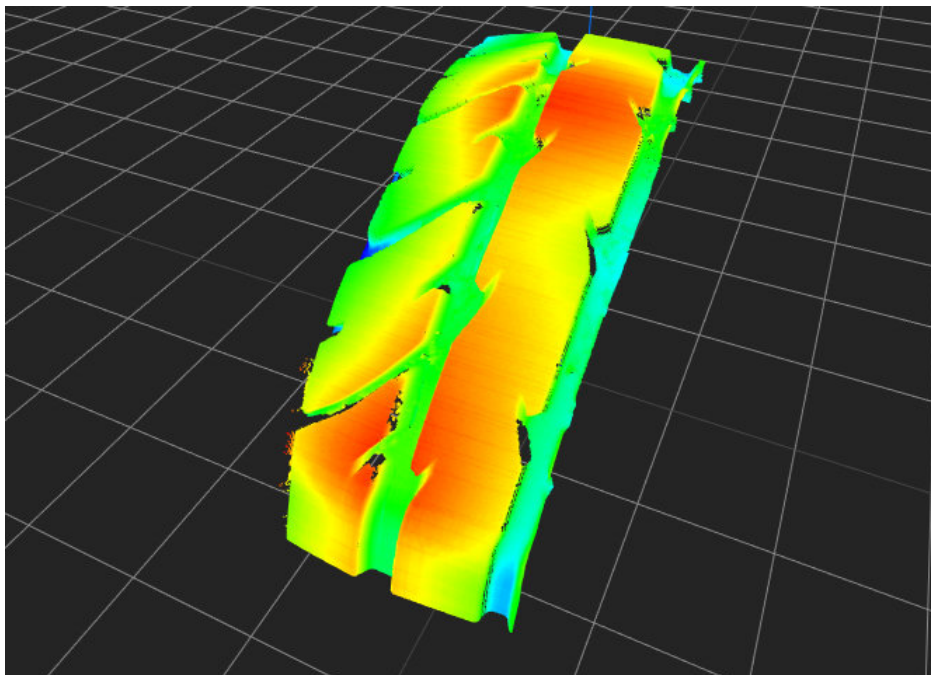

Point cloud with coloring by height

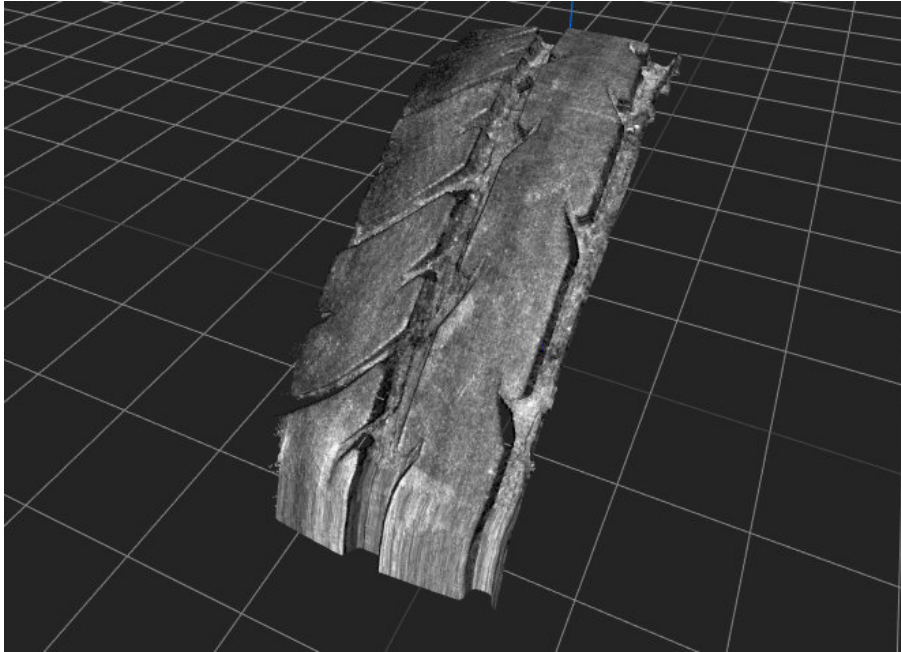

Point cloud with coloring by intensity

16.2.3. Export of accumulated profiles

When the **Profile** tab is selected in **Dump** mode, the **Save** button is available. If you click this button, the file with accumulated profiles in **.bin** format will be generated and downloaded from the scanner. The description of the **.bin** format is given in the Programmer's guide.

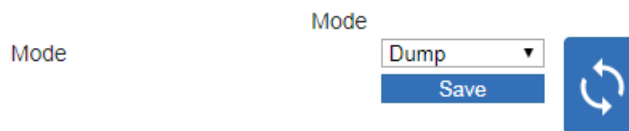

To view the accumulated profiles in **.bin** format, use the **RFProfileView** program (<https://riftek.com/downloads/RFProfileView.zip>).

When the **3D** tab is selected in **Dump** mode, the **Export** button is available. If you click this button, the file with a point cloud in **.obj** format will be generated and downloaded from the scanner.

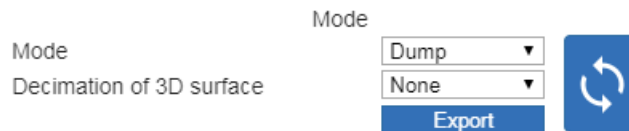

The **.obj** format is a commonly available format for describing 3D geometry and can be opened by almost any software for working with 3D objects (for example, the **MeshLab** software). Download link: <https://www.meshlab.net/#download>

17. Setting parameters

To configure the scanner settings, go to the required tab and make changes.

All settings, except network settings, are applied immediately. In order for the network settings to take effect, it is necessary to click the **Change** button. All changes are made in RAM and will be lost when you restart the scanner. If you want to save parameters, write them to the nonvolatile memory of the scanner before restarting. Control buttons are located in the upper right corner of the window (see par. 14.).

18. "Network" tab. Network parameters

To configure the network parameters of the scanner, go to the **Network** tab.

Current Network settings:

Parameter	Factory value	Description
Speed (Mbps)	Auto negotiation	Connection speed. Available modes: <ul style="list-style-type: none"> • Auto negotiation (connection speed auto negotiation); • 100 Mbps; • 1000 Mbps.

Current IP settings:

Parameter	Factory value	Description
IP address	192.168.1.30	IP address of the scanner.
Gateway	192.168.1.1	Gateway address.
Subnet mask	255.255.255.0	Network mask.
Host IP address	192.168.1.2	IP address of the PC (or other network device) that receives profiles.
Service port	50011	Scanner port number for the service protocol.
Destination port	50001	Port number of the PC (or other network device) that receives profiles, to which the scanner must send UDP packets with profiles.



In order for the changes to take effect, it is necessary to click the **Change** button.

19. "General" tab. General parameters

19.1. Image quality settings

The intensity of the reflected light entering the scanner depends on the properties of the surface of the object under control. In turn, the value of electric signal generated by the CMOS image sensor of the scanner depends on the time of accumulation of radiation (exposure time). Therefore, in order to obtain optimal signal, it is necessary to set optimal exposure time.

Since the exposure time cannot exceed the frame duration, it is necessary to set the required frame rate (**FPS** parameter) before setting the exposure time.

19.1.1. Frame rate



Parameters:

Parameter	Factory value	Description
FPS	484	The current number of profiles (frames) per second that the scanner processes and transfers.
Double frame speed (DS Mode)	OFF	Enable / disable the double frame rate mode: <ul style="list-style-type: none"> • ON - enabled, the scanner works in the DS mode; • OFF - disabled, the scanner works in the standard mode. Note: In this mode, the linearity of the scanner for Z is reduced from $\pm 0.05\%$ to $\pm 0.1\%$ of the measuring range for Z.

To set the **FPS** parameter, use the slider, or enter the required value into the field and press the **Enter** key (valid for standard operation mode, as well as for **DS** and **ROI** modes). The maximum possible value for the current mode is shown next to the **FPS** field.

19.1.2. Exposure time and laser power



Parameters:

Parameter	Factory value	Description
Exposure time, ns	300000	Exposure time of the CMOS sensor (signal accumulation time) in nanoseconds, step 10 ns. The minimum value is 3000 ns, the maximum possible value depends on the frame rate, the ROI and DS modes, and is limited to 1/FPS. Note: The laser automatically turns on during the exposure time only.
Autoexposure	OFF	Enable / disable the autoexposure mode: <ul style="list-style-type: none"> • OFF - manual mode; • ON - autoexposure mode.
Laser ON/OFF	ON	Turn on / off the laser: <ul style="list-style-type: none"> • OFF - laser is off; • ON - laser is on.
Laser output power, %	10	Laser output power level. Range of values: 0...100%. Note: The laser output power is adjustable only in manual mode.

Exposure time and laser output power are set manually based on visual analysis of the quality of the image obtained from the image sensor, and on analysis of the quality of the resulting profile (see p. 16.).

To set the exposure time, use the slider, or enter the required value into the field and press the **Enter** key. For convenience, you can select **Profile data format > Raw profile** (see the **Data stream options** section of the **General** tab). In this case, the **Video** tab simultaneously displays a video signal and an extracted profile in the coordinate system of the CMOS sensor (uncalibrated data).

To enable the autoexposure mode, click **Auto exposure**. The scanner will automatically set the optimal exposure time.

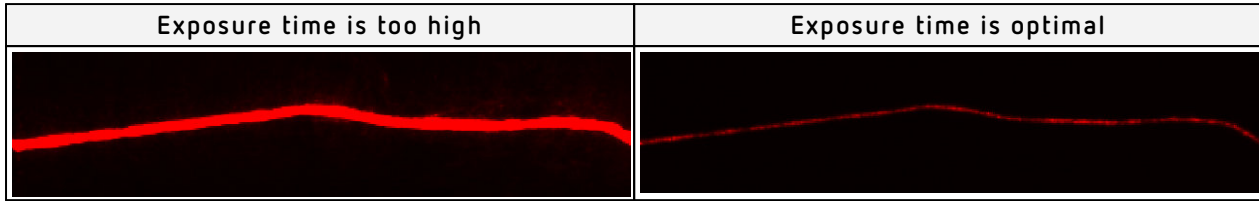

19.2. ROI settings

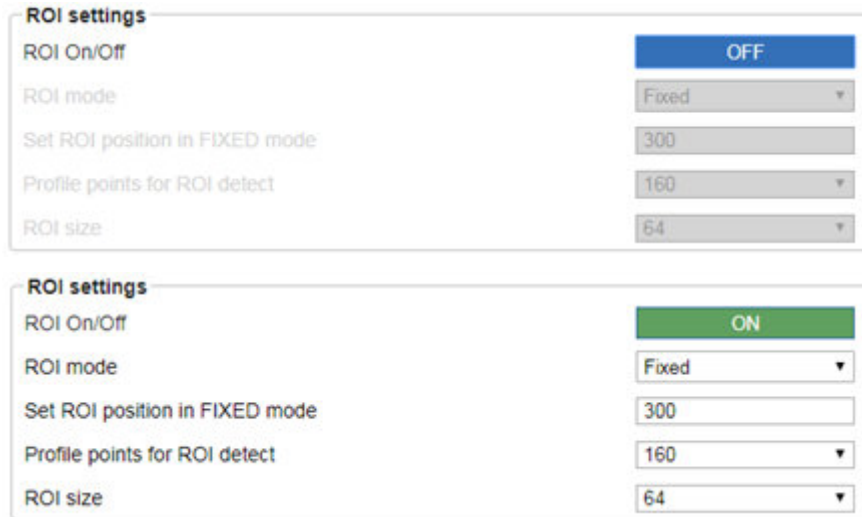

The **ROI** (region of interest) parameters control the size and position of the CMOS sensor active area. By default, the active area covers the entire area of the sensor. Decreasing the active area size allows to increase the scanner speed due to decreasing of the image reading time. Resizing is possible in Z-direction only and is performed in the coordinate system of the CMOS sensor.

Parameters:

Parameter	Factory value	Description
ROI On/Off	OFF	Enable/disable the ROI mode: <ul style="list-style-type: none"> • ON - enabled; • OFF - disabled. When this mode is enabled, the CMOS sensor processes a part of the active area set by the ROI position and ROI size parameters. The frequency of profiles increases inversely with the size of the region of interest (ROI size).
ROI mode	FIXED	ROI modes: <ul style="list-style-type: none"> • FIXED - Manual mode. The position of the region of interest is fixed and is determined by the ROI position parameter. The size of the area is determined by the ROI size parameter. • AUTO - Auto mode. The region of interest automatically moves within the working range of the scanner in order to keep the profile image within the boundaries of the specified area. This mode makes it possible to work in the entire working range of the scanner with the increased speed.
Set ROI position in FIXED mode	300	The position of the upper boundary of the region of interest in the FIXED mode. Valid values: from 0 to (488 - ROI Size).
ROI size	64	The size of the region of interest. Valid values: from 24 to 480 with the step of 8.

Parameter	Factory value	Description
Profile points for ROI detect	324	This parameter is active in the AUTO mode. It sets the number of points in the profile, which indicates that the profile is located within the region of interest. If the number of points in the region of interest is less than the specified value, the scanner automatically starts searching for the profile on the entire field of the CMOS sensor (the region of interest expands to the entire CMOS sensor with a corresponding change in speed). When the specified number of profile points is detected, the scanner automatically returns to the specified ROI size. Valid number of points: from 1 to 648. The size of the region of interest is determined by the ROI size parameter, the ROI position parameter is changed automatically.

Example: Automatic displacement of the region of interest with keeping the profile within the set boundaries (yellow lines).

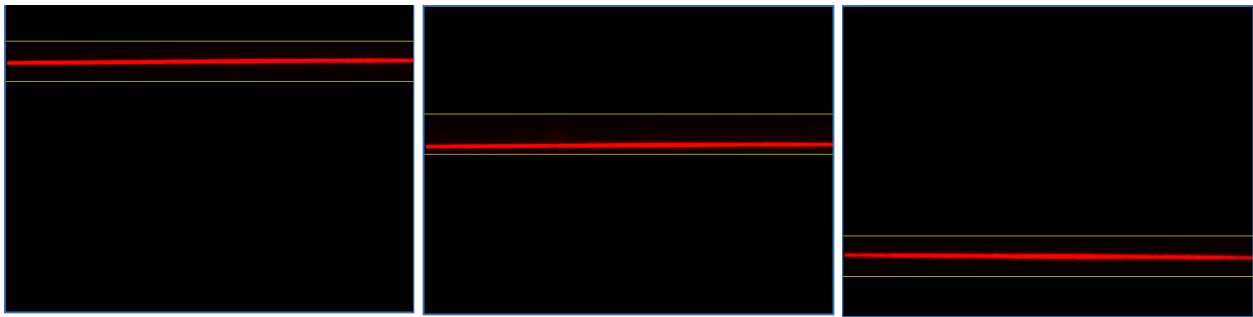

19.3. Data stream control

The **Data stream options** parameters control the data stream of the scanner and the resolution by X coordinate.

Data stream options

Profile data UDP stream on/off ON

X-Axis Resolution 648 ▼

Profile data format Calibrated Profile ▼

Include intensity in profile data OFF

Parameters:

Parameter	Factory value	Description
Profile data UDP stream on/off	ON	Enable/disable the UDP data stream.
X-Axis Resolution	1296	Number of points by Xcoordinate (648 or 1296).
Profile data format	Calibrated profile	Profile formats: <ul style="list-style-type: none"> • Calibrated profile- transfer of calibrated data (profile in Cartesian coordinates of the measuring area). • RAW profile- transfer of uncalibrated data (profile in the coordinate system of the CMOS sensor). Obtaining a profile in this format allows you to visually match the profile and the image formed by the CMOS sensor. This format is used for debugging.
Check delivery	OFF	Enable/disable the requirement to confirm delivery of UDP packets with profiles: <ul style="list-style-type: none"> • ON - enabled; • OFF- disabled.

Parameter	Factory value	Description
Include intensity in profile data	OFF	Include the point intensity values into the profile package: ON - point intensity values are included in the profile package; OFF - point intensity values are not included in the profile package. The description of the data format is given in the Programmer's Guide.

20. "Profile processing" tab. Profile extraction settings

The **Profile processing** tab contains parameters that control the procedure for extracting a profile from an image and filtering points of a selected profile (**Pre Processing** section), as well as parameters that control the point cloud display parameters (**Dump Control** section).

20.1. "Pre Processing" section. Profile extraction parameters setting

The parameters of the **Pre processing** section define characteristics of the profile extraction algorithm.

Pre processing

Processing mode High accuracy ▼

Peak selection mode Max intensity ▼

Detection threshold, % 10

Interleaved HDR OFF

Interleaved exposure divider 5 ▼

Exposure HDR OFF

Image flip X ▼

Parameters:

Parameter	Factory value	Description
Processing mode	High accuracy	Two modes are available: High accuracy and Welding . The Welding mode is intended to be used with the scanners installed on welding robots and operating under conditions of strong light interference.
Peak selection mode (see par. 20.1.1.)	Max intensity	The algorithm for determining the peak brightness in the image column to obtain the profile point. This parameter is used for suppression of multiple reflection light image Modes: <ul style="list-style-type: none"> • Max intensity – Selection of the peak with the greatest brightness; • First – Selection of the first peak in the column above; • Last – Selection of the last peak in the column above; • #2...#6 – Selection of the peak in the column above with the corresponding number.
Detection threshold, %	10	This parameter determines the profile detection level. Increasing this parameter makes it possible to reduce the effect of image noise caused by, for example, ambient light. Range of values: 0...100%. If the value is 100%, the image is not processed.

Parameter	Factory value	Description
Interleaved HDR	OFF	This mode is designed to expand the dynamic range of the sensor. It is used in the control of complex objects containing areas with different reflectivity. The expansion of the dynamic range is achieved due to different exposure times for the even and odd columns of the CMOS sensor. For odd columns, the exposure time is lower. Exposure time reduction is determined by the Interleaved exposure divider coefficient.
Interleaved exposure divider	5	Exposure time reduction coefficient for odd columns of the CMOS sensor. It determines how many times the exposure time for odd columns is reduced relative to the main exposure time (Exposure time, ns on the General tab). It is available only when the Interleaved HDR mode is enabled. Possible values: 5, 10, 15, 20.
Exposure HDR (see par. 20.1.2.)	OFF	This mode is designed to expand the dynamic range of the sensor. It is used in the control of complex objects containing areas with different reflectivity. The expansion of the dynamic range is achieved due to the use of a piecewise linear response of the CMOS sensor.
Image flip	NO	Flip the CMOS sensor image in the direction of the selected axes. Possible options: No - no flip; X- flip along the Xaxis of the scanner; Z - flip along the Zaxis of the scanner; XZ - flip along both axes.

20.1.1. "Peak selection mode" parameter

The **Peak selection mode** parameter defines the algorithm for detecting the brightness peak in the column of the CMOS sensor to obtain the profile point. Changing this parameter helps to correctly extract the profile in the case of laser beam re-reflections from the object surface or in the case of brightening from external sources of optical radiation.

The intensity of the re-reflected beam or brightening from external light sources can sometimes exceed the intensity of the laser line. In this case, you can use the modes with an indication of a more specific detection point.

Example:

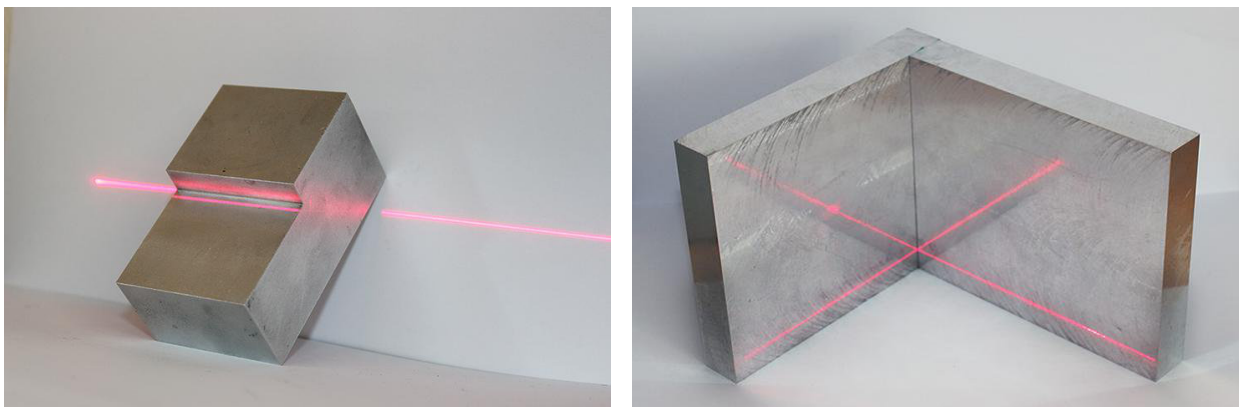

Re-reflections of a laser beam on the object having a complex profile

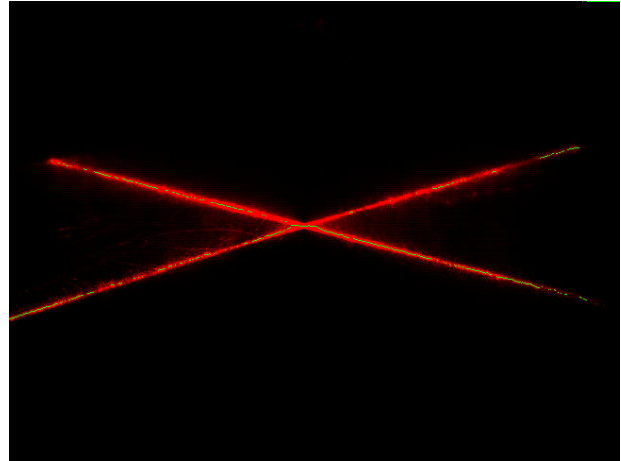

The **Max Intensity** value determines the selection of the profile point based on the maximum brightness of the image in the CMOS sensor column. The brightness of the re-reflected signal may be greater than the brightness of the original signal. The scanner incorrectly selects the profile, placing it both on the initial laser line and on the re-reflexion.

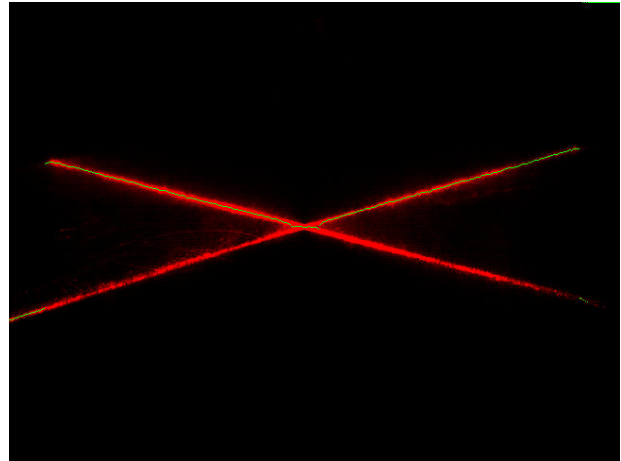
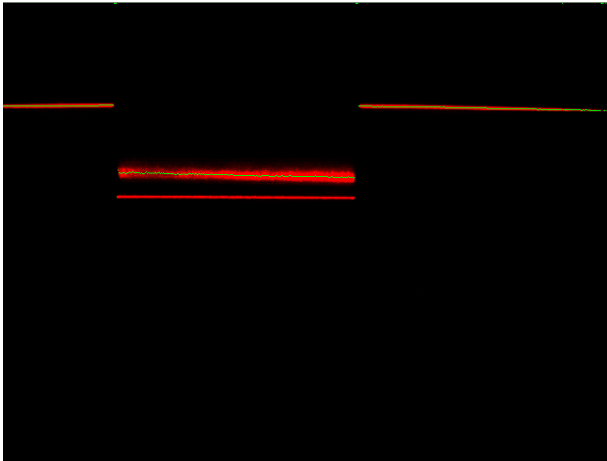

The **First** value determines the selection of the first peak in the CMOS sensor column. The scanner selects a profile by a re-reflected signal.

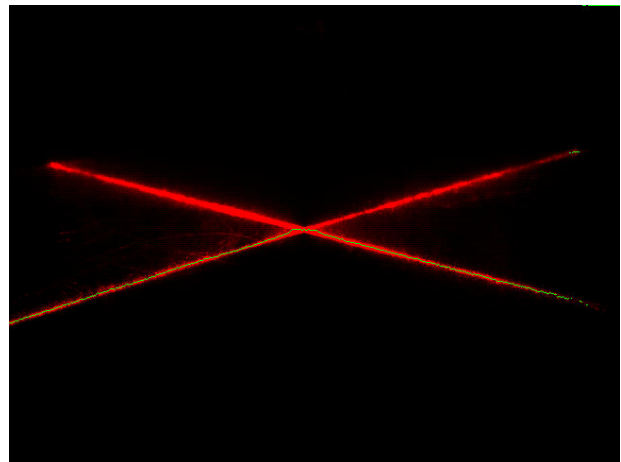
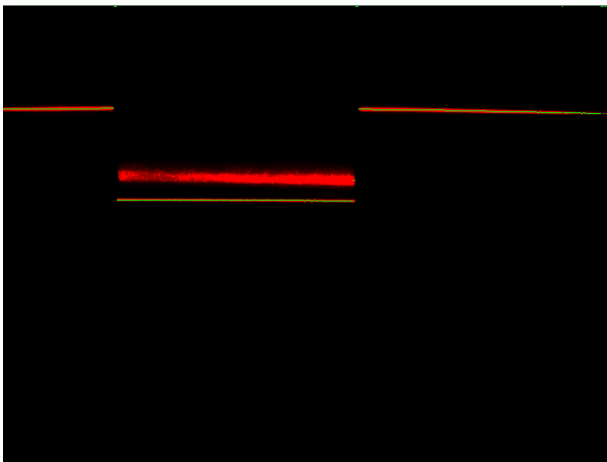

The **Last** value determines the selection of the last peak in the CMOS sensor column. The scanner selects a profile by a real signal.

20.1.2. "Exposure HDR" parameter

The **Exposure HDR** parameter is intended to expand the dynamic range of the scanner. It is used in cases when you need to scan the surfaces with different reflectance.

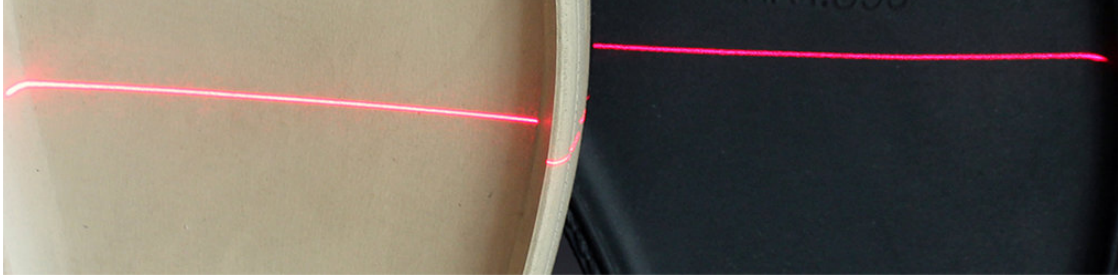

Scanner sees two objects: one of light color and the other of dark color.

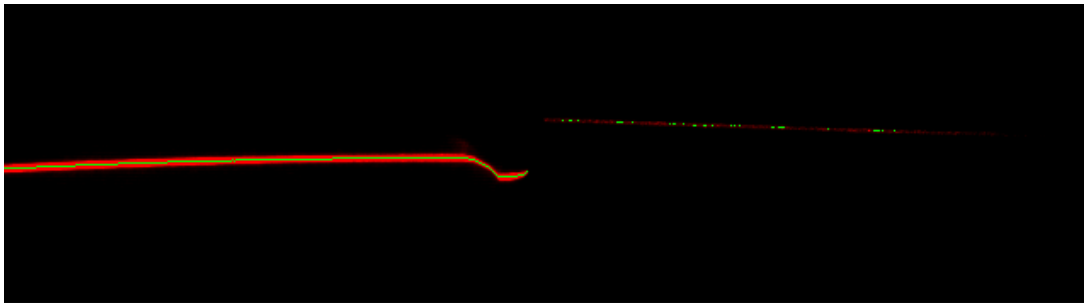

With a lower exposure time, the profile of the object of light color looks well-defined; black object shows only a few profile points.

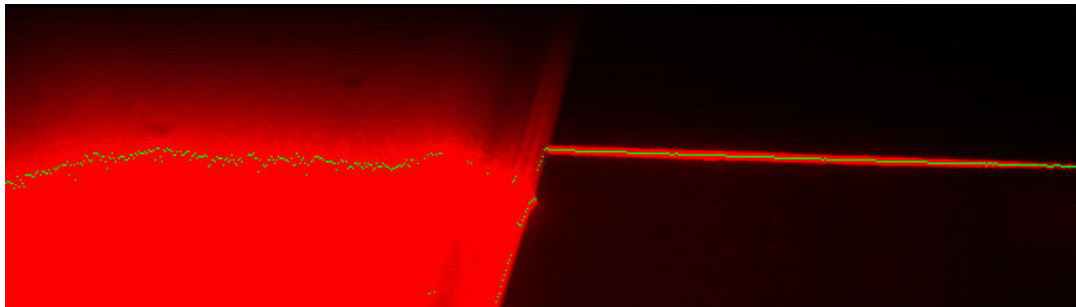

When increasing the exposure time, the black object profile is well-defined, but the light one is not.

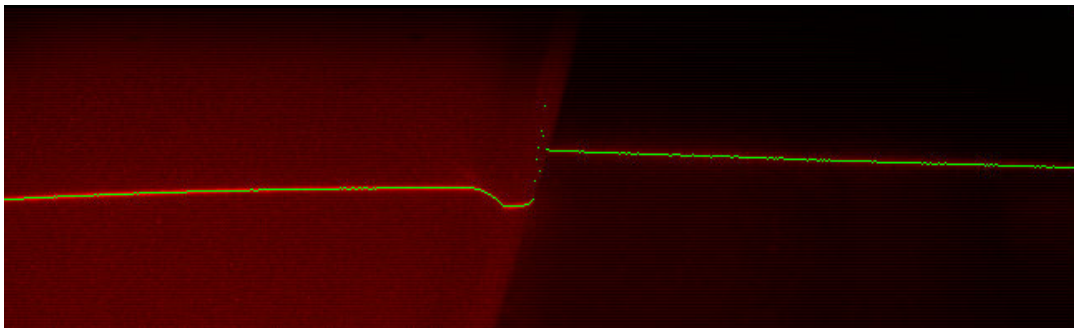

The exposure time is the same as in the previous figure, but the **Exposure HDR** mode is turned on. Profiles of both objects are well-defined.

20.2. "Post Processing" section. Filtering

The parameters of the **Post processing** section define the operations performed directly on the profile points.

Post processing

Suppression of unstable points OFF

Median filter width 0 ▼

Bilateral filter width 0 ▼

Parameters:

Parameter	Factory value	Description
Suppression of unstable points	OFF	ON - unstable points will be deleted from the profile (the points are considered unstable if they are not detected at least once in 128 profiles in a row).
Median filter width	0	The size (number of points) of the median filter window. Possible values: 0, 3, 5, 7, 9, 11, 13, 15. If the value is set to "0", the filter is disabled.
Bilateral filter width	0	The size (number of points) of the bilateral smoothing filter window. Possible values: 0, 3, 5, 7, 9, 11, 13, 15. If the value is set to "0", the filter is disabled.

20.3. "Dump Control" section. Building 3D models

The parameters of the **Dump Control** section define the parameters for displaying a three-dimensional point cloud.

Dump Control

Type of displacement system Linear ▼

Step size, mm 0.000000100000

Step selector Time ▼

Coloring mode Heightmap ▼

Parameters:

Parameter	Factory value	Description
Type of displacement system	Linear	Type of mechanical displacement system for obtaining a point cloud: <ul style="list-style-type: none"> • Linear – Linear displacement system. The scanner (object) moves along a straight path; • Radial – Angular displacement system. The scanner doesn't move. The scanned object rotates around its own axis. The axis of rotation of the object coincides with the Xemr line of the scanner range. This mode is used to receive point clouds of rotation bodies.
Step size	0	Step size between measurements (in millimeters for the Linear system, and in degrees for the Radial system).
Step selector	Time	Selector, which is used to build a point cloud. The step value is multiplied by the value of the parameter selected by the selector. <ul style="list-style-type: none"> • Time – Time stamp in the profile; • Step counter – Encoder counter; • Measurement counter – Internal measurement counter.

Parameter	Factory value	Description
Coloring mode	Heightmap	Point cloud coloring mode: <ul style="list-style-type: none"> • Heightmap – Coloring by height (for the Linear system) or according to removal from an axis (for the Radial system); • Intensity – Coloring according to the pixel intensity values. Note: Coloring in Intensity mode is possible only if intensity values have been included in the profile package (see par. 19.3.).

21. "Triggering settings" tab. Triggering modes

21.1. Time cycle

Image capture, processing (profile extraction) and result transfer are performed in a pipeline mode. The pipeline mode is illustrated by the following diagram:

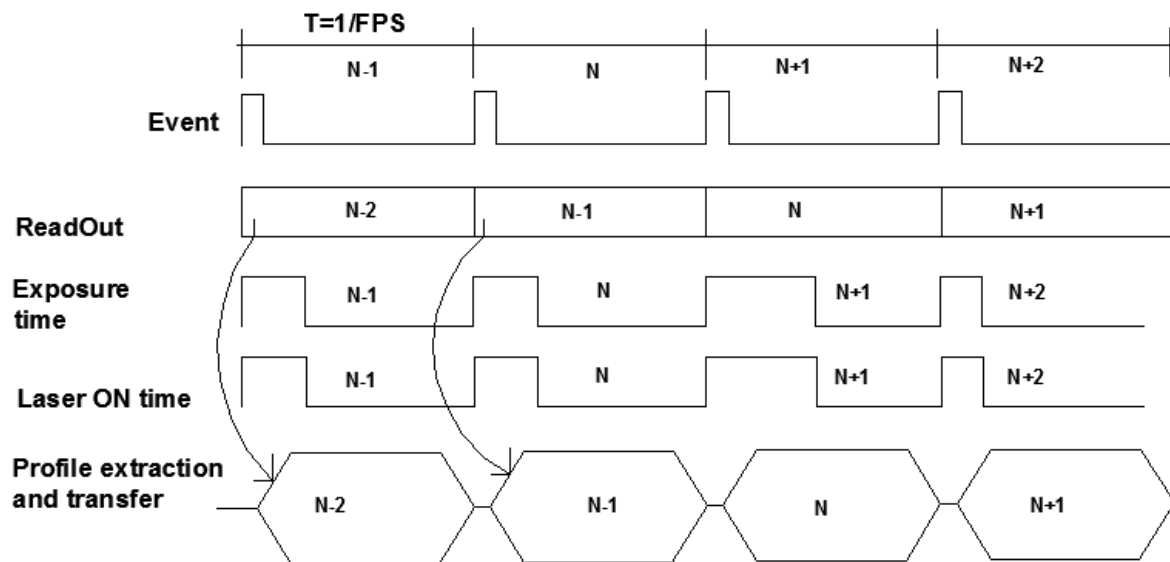

Description:

T	Frame (profile) period.
FPS	Frame (profile) rate.
N-1, N...	Frame (profile) numbers.
Event	Event that triggers the measurement cycle of obtaining a single frame (profile).
Exposure time	Exposure time of the image sensor.
Laser ON time	Time during which the laser is turned on.
Profile extraction and transfer	Time required to extract the profile and start its transfer.

The measuring cycle (start of measurement to take one profile) always begins with an event, the sources of which are described in the next paragraph. Upon the occurrence of the event, the electronic shutter is opened and the laser is turned on, i.e. the CMOS sensor is exposed. At the same time, the previous frame is read, processed (profile is extracted from image) and transmitted.

21.2. Triggering modes

The **Inputs** section of the **Triggering settings** tab is intended to setup the measurement triggering modes. The required mode is selected from the drop-down menu:



If the selected mode allows for options, set the required values in the appropriate fields:

<p>Triggering settings</p> <p>Inputs</p> <p>Preset: Internal clock</p> <p>Input 1: Not active</p> <p>Measurement start: Rise</p> <p>Measurement delay (step 10 ns.): 30 ≤ 1.00 s</p> <p>Measurement divider: 1 ≤ 65535</p> <p>Input 2: Not active</p> <p>Input 3: Not active</p> <p>Zero mark: Rise</p> <p>#0 Internal Clock</p>	<p>Triggering settings</p> <p>Inputs</p> <p>Preset: External trigger</p> <p>Input 1: Active</p> <p>Measurement start: Rise</p> <p>Measurement delay (step 10 ns.): 30 ≤ 1.00 s</p> <p>Measurement divider: 1 ≤ 65535</p> <p>Input 2: Not active</p> <p>Input 3: Not active</p> <p>Zero mark: Rise</p> <p>#1 External trigger</p>	<p>Triggering settings</p> <p>Inputs</p> <p>Preset: 1-ph. encoder</p> <p>Input 1: Active</p> <p>Measurement start: Rise</p> <p>Measurement delay (step 10 ns.): 30 ≤ 1.00 s</p> <p>Measurement divider: 1 ≤ 65535</p> <p>Input 2: Not active</p> <p>Input 3: Not active</p> <p>Zero mark: Rise</p> <p>#2 1-phase encoder</p>
<p>Triggering settings</p> <p>Inputs</p> <p>Preset: 1-ph. encoder + "Z"</p> <p>Input 1: Active</p> <p>Measurement start: Rise</p> <p>Measurement delay (step 10 ns.): 30 ≤ 1.00 s</p> <p>Measurement divider: 1 ≤ 65535</p> <p>Input 2: Not active</p> <p>Input 3: Active</p> <p>Zero mark: Rise</p> <p>#3 1-phase encoder+Z</p>	<p>Triggering settings</p> <p>Inputs</p> <p>Preset: 2-ph. encoder</p> <p>Input 1: Active</p> <p>Measurement start: Rise</p> <p>Measurement delay (step 10 ns.): 30 ≤ 1.00 s</p> <p>Measurement divider: 1 ≤ 65535</p> <p>Input 2: Active</p> <p>Input 3: Not active</p> <p>Zero mark: Rise</p> <p>#4 2-phase encoder</p>	<p>Triggering settings</p> <p>Inputs</p> <p>Preset: 2-ph. encoder + "Z"</p> <p>Input 1: Active</p> <p>Measurement start: Rise</p> <p>Measurement delay (step 10 ns.): 30 ≤ 1.00 s</p> <p>Measurement divider: 1 ≤ 65535</p> <p>Input 2: Active</p> <p>Input 3: Active</p> <p>Zero mark: Rise</p> <p>#5 2-phase encoder+Z</p>
<p>Triggering settings</p> <p>Inputs</p> <p>Preset: Step/Dir</p> <p>Input 1: Active</p> <p>Measurement start: Rise</p> <p>Measurement delay (step 10 ns.): 30 ≤ 1.00 s</p> <p>Measurement divider: 1 ≤ 65535</p> <p>Input 2: Active</p> <p>Input 3: Not active</p> <p>Zero mark: Rise</p> <p>#6 Step/Dir</p>	<p>Triggering settings</p> <p>Inputs</p> <p>Preset: Ext.trigger/Int.clock</p> <p>Input 1: Active</p> <p>Measurement start: High level</p> <p>Measurement delay (step 10 ns.): 30 ≤ 1.00 s</p> <p>Measurement divider: 1 ≤ 65535</p> <p>Input 2: Not active</p> <p>Input 3: Not active</p> <p>Zero mark: Rise</p> <p>#7 External trigger/Internal clocks</p>	<p>Triggering settings</p> <p>Inputs</p> <p>Preset: Software request</p> <p>Input 1: Not active</p> <p>Measurement start: High level</p> <p>Measurement delay (step 10 ns.): 30 ≤ 1.00 s</p> <p>Measurement divider: 1 ≤ 65535</p> <p>Input 2: Not active</p> <p>Input 3: Not active</p> <p>Zero mark: Rise</p> <p>#8 Software request</p>

Description of triggering modes:

Mode name	Event source	How it works	Options	How to install
#0 Internal Clock	Internal clock	Profiles are transmitted continuously at the set frame rate (FPS).		See par. 19.1.1 .
#1 External trigger	External trigger, start of a single measurement	Each measurement starts with receiving of the trigger signal at input #1 with the set start delay.	<ul style="list-style-type: none"> Start measurement at the rise edge of the input pulse Start measurement at the fall edge of the input pulse Delay Divider 	<ul style="list-style-type: none"> Connect a source to input #1 Select Rise / Fall If necessary, set the value of the Measurement delay If necessary, set the value of the Input divider
#2 1-phase encoder	Encoder, one phase	Each measurement starts with receiving the encoder signal at input #1 with the set division ratio.	<ul style="list-style-type: none"> Start measurement at the rise edge of the input pulse Start measurement at the fall edge of the input pulse Divider 	<ul style="list-style-type: none"> Connect a source to input #1 Select Rise / Fall If necessary, set the value of the Input divider
#3 1-phase encoder	Encoder, one phase and "0" mark	Each measurement starts with receiving the encoder signal (front) at input #1 with the set division ratio. The measurement counter is reset on phase Z.	<ul style="list-style-type: none"> Start measurement at the rise edge of the input pulse Start measurement at the fall edge of the input pulse Divider 	<ul style="list-style-type: none"> Connect phase A or B to input #1 Select Rise / Fall Connect phase Z to input #3 If necessary, set the value of the Input divider
#4 2-phase encoder	Encoder, two phases	Each measurement starts with receiving quadrature encoder signals (multiplication by 4) to the inputs #1 and #2 with the set division ratio. The direction of movement is controlled, the indication of the direction is transmitted in the data packet.	Divider	<ul style="list-style-type: none"> Connect phase A to input #1 Connect phase B to input #2 If necessary, set the value of the Input divider
#5 2-phase encoder+ Z	Encoder, two phases and "0" mark	Each measurement starts with receiving quadrature encoder signals (multiplication by 4) to the inputs #1 and #2 with the set division ratio. The direction of movement is controlled, the indication of the direction is transmitted in the data packet. The measurement counter is reset on phase Z.	Divider	<ul style="list-style-type: none"> Connect phase A to input #1 Connect phase B to input #2 Connect phase Z to input #3 If necessary, set the value of the Input divider
#6 Step/Dir	Step/Dir signal (Step/Direction)	Each measurement starts with receiving the Step signal at input #1 with the set division ratio. The indication of the direction is transmitted in the data packet.	<ul style="list-style-type: none"> Start measurement at the rise edge of the input pulse Start measurement at the fall edge of the input pulse Divider 	<ul style="list-style-type: none"> Connect the Step signal to input #1 Select Rise / Fall Connect the Dir signal to input #2 If necessary, set the value of the Input divider

Mode name	Event source	How it works	Options	How to install
#7 External trigger/Internal clocks	External trigger. Run a series of measurements on the internal clock	The series of measurements with the set frame rate (FPS) starts with receiving a signal at input # 1. The series of measurements stops when the signal level changes.	<ul style="list-style-type: none"> Start the series of measurements at a high level of the pulse Start the series of measurements at a low level 	<ul style="list-style-type: none"> Connect a source to input #1 Set the required value of High Level or Low Level
#8 Software request	Software request	Each measurement starts with receiving the software request		See Programmer's Guide

Notes:

1. The maximum processed frequency at the inputs #1, #2 and #3 is 10 MHz. If the event arriving rate is higher than the FPS, the measurement is started at the closest event after the end of the current cycle. The minimum allowable pulse duration is 40 ns. When using the **Input divider**, the frequency of the events, triggering the measurement, equals to (input frequency) / (divider value).

2. The data packet with the profile coordinates, transmitted by the scanner (see the Programmer's Guide), carries information about the contents of several cyclic counters, allowing you to control the integrity of the data:

- System time counter for the beginning of each measurement.
- Input pulse counter. This counter is incremented by the input signal (input signals for modes #4 and #5). The counter is not reversible. The indication of the direction is transmitted in the data packet.
- Measurement counter (frame counter). This counter is incremented by the event that triggers the measuring cycle.

22. "Triggering settings" tab. Synchronization of multiple scanners

Where measurements are made by several scanners, it is often necessary to ensure **synchronous** measurements, in order, for example, to combine profiles obtained from different parts of the moving object into a single profile.

When installing scanners in a line or around an object or opposite each other, it becomes necessary to ensure **asynchronous** measurements in order to eliminate the mutual influence of laser beams on each other.

To synchronize the operation of multiple scanners, the OUT output of one of the scanners is used. The Rise of the scanner output signal always corresponds to the moment of switching on the laser of the scanner (the beginning of the integration time), the signal Fall corresponds to the moment of switching off the laser (the end of the integration time). The output signal delay relative to the on / off time of the laser is about 50 ns.

22.1. Synchronous measurements

There are two options for connecting the scanners for synchronous measurements. Option 1. All scanners in the system are configured to work in one of the 8 modes #1...#8, (mode #0 is not used). The event source is connected simultaneously (in parallel) to all scanners.

Option 2.

- One of the scanners (Master) is configured in the required mode, #0...#8.
- The OUT Master output is initialized.

Outputs
Output 1 ON/OFF ON

- The other scanners (Slave) are switched to mode #1 (External trigger) with **Measurement start** - Rise.
- The Master output is connected to Input #1 of all Slave scanners.

22.2. Asynchronous measurements

To perform asynchronous measurements, scanners are connected as follows:

- One of the scanners (Master) is configured in the required mode, #0...#8.
- The other scanners (Slave type 1 and Slave type 2) are switched to mode #1 (External trigger).
- For nearby scanners (Slave type 1 and Slave type 2), the following options are set: **Measurement start** - Fall and **Measurement start** - Rise.
- The OUT Master output is initialized.

Outputs
Output 1 ON/OFF ON

- The Master output is connected to Input #1 of all Slave scanners.

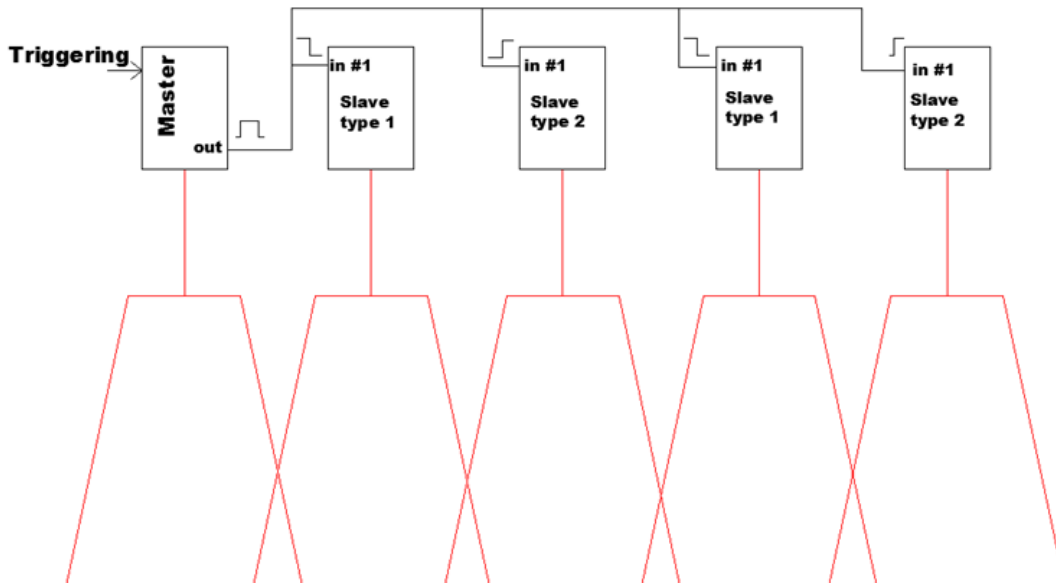

As a result, the lasers of the scanners of the "Master + Slave type 2" group and the "Slave type 1" group will alternately turn on.

Note: The total accumulation time of the Slave type 1 and Slave Type 2 scanners must not exceed the measuring cycle time = 1 / FPS.

23. "System" tab

23.1. Scanner name change. Log files

In the **General** section, you can change the scanner name by typing a new name into the field and clicking **Change**, or you can enable / disable saving the log file to the internal memory of the scanner.

General

Scanner name Change

Save LOG to internal memory ON

23.2. Compatibility with FDRF625 scanners

In the **Compatibility** section, you can switch the scanner to **Protocol backward compatibility** mode by changing the **OFF** state to **ON**. In this mode, data (profiles) are transmitted according to the RF625 scanner protocol. Parameterization is carried out through the WEB-interface.

NOTE: When the **Protocol backward compatibility** mode is enabled, it is not possible to change the **Profile data UDP stream parameter on / off** in the **Data stream options** section (see par. [19.3](#)).

Compatibility

Protocol backward compatibility OFF

This mode uses destination port from network settings

23.3. Firmware update

To update firmware, go to the **Firmware update** tab.

Firmware update **Calibration table write**

File path Choose File

Upload

Start

- Click **Choose File** and select the firmware file.
- Click **Upload** to upload the selected file.
- Click **Start** to start the update process. You will see:

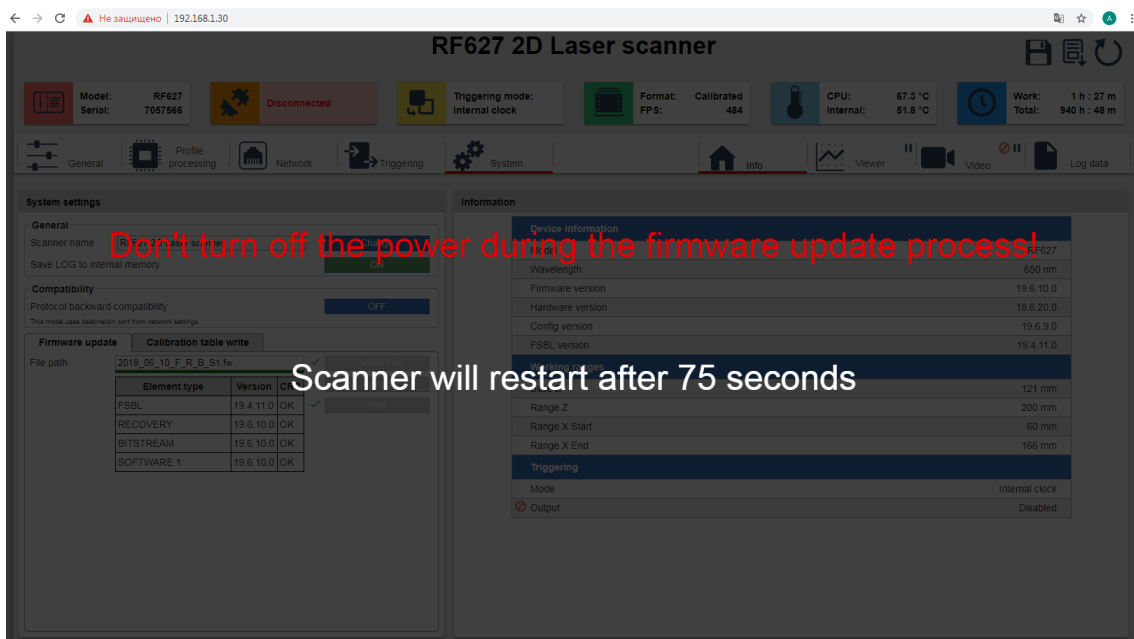

If the IP address settings haven't been changed after completing the firmware update process and restarting the scanner, the web interface will automatically reboot without waiting for the timer to expire. If the network settings have been changed, the web interface will reboot with the default IP address (192.168.1.30) after the timer expires.

23.4. Calibration table update

To update the calibration table, select the **Calibration table write** tab.

The screenshot shows the 'Calibration table write' tab in the web interface. On the left, there is a 'File path' label and a 'Choose File' button. Below this is a table with four rows: 'Serial', 'Save date', 'Save time', and 'CRC', each with a '-' in the adjacent column. To the right of this table are three buttons: 'Choose File' (blue), 'Upload' (grey), and 'Start' (grey).

- Click **Choose File** and select the calibration table file.
- Click **Upload** to upload the selected file.
- Click **Start** to start the update process. In case of successful update, you will see:

Serial	Scanner serial number
Save date	Table creation date
Save time	Table creation time
CRC	Checksum. OK - table is uploaded correctly, ERR - file is damaged, uploading is impossible.

24. "Info" tab

The **Info** tab displays general information about the scanner.

The screenshot shows the 'Information' tab with the following data:

Device information	
Model	Laser scanner
Wavelength	650 nm
Firmware version	19.6.10.0
Hardware version	18.6.20.0
Config version	19.6.9.0
FSBL version	19.4.11.0
Working ranges	
Base Z	121 mm
Range Z	200 mm
Range X Start	60 mm
Range X End	166 mm
Triggering	
Mode	Internal clock
✓ Output	Enabled

25. "Log data" tab

The **Log data** tab displays information about the scanner operation that can be used to detect errors:

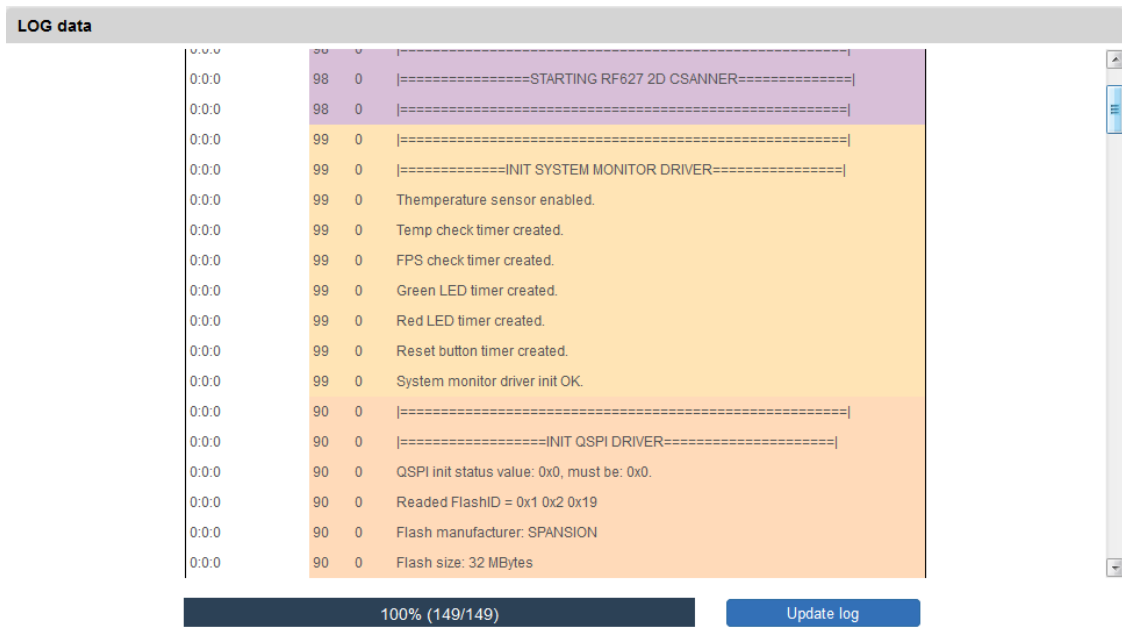

This tab contains information about the operations performed and their order.

26. Maintenance

The Laser Scanners is virtually maintenance free. As these are optical systems, they are sensitive to dust and sputter on the front windows. Cleaning is best done with a soft cloth. Do not use scratching cleaners or other aggressive media.

It is necessary to remove fingerprints from the windows, because fingerprints degrade the quality of profiles.

In order to remove fingerprints or grease, clean the windows with 20% alcohol and soft paper.

27. Troubleshooting

Problem	Cause	Solution
Laser is off	No power supply (or less than 9 V)	Check the power supply
	Power cable or Ethernet are not connected	Check the cables connection
	Scanner electronics failure	Contact the technical support
No scanners on the network	No power supply (or less than 9 V)	Check the power supply
	Ethernet cable or /and power cable are not connected	Check the cables
	Incorrect settings of the network card of the PC	Check the network card configuration (see par. 12.1.)
	Scanner freezes	Reboot the scanner
	Scanner electronics failure	Contact the technical support
No profile	Low exposure time	Check the exposure time
	The object is beyond the working range of the scanner	Install the object within the working range of the scanner

Problem	Cause	Solution
	ROI mode is enabled and the object is beyond the set ROI area	Check the ROI settings
Incorrect profile	Scanner windows are not clean	Clean the windows as described in par. 26 .
	Incorrect scanner settings	Check settings
	Measurements are taken in locations close to powerful light sources	Do not use the scanner in locations close to powerful light sources

28. Annex 1. Recovery Mode

Recovery mode is intended to restore the scanner operability in case of hardware failures or after incorrect user actions.

To activate this mode, it is necessary to turn on the scanner with the **Reset** button pressed and continue to hold this button pressed for at least 10 seconds.

In this mode, the **PWR** indicator displays the SOS signal (three short - three long - three short), which means that the scanner is in **Recovery** mode now.

After turning off the scanner, it will operate in basic mode when turned on again. In **Recovery** mode, when you enter the IP address of the scanner into the address bar of the browser, a simplified WEB page will be loaded. In this page, you can perform the following actions:

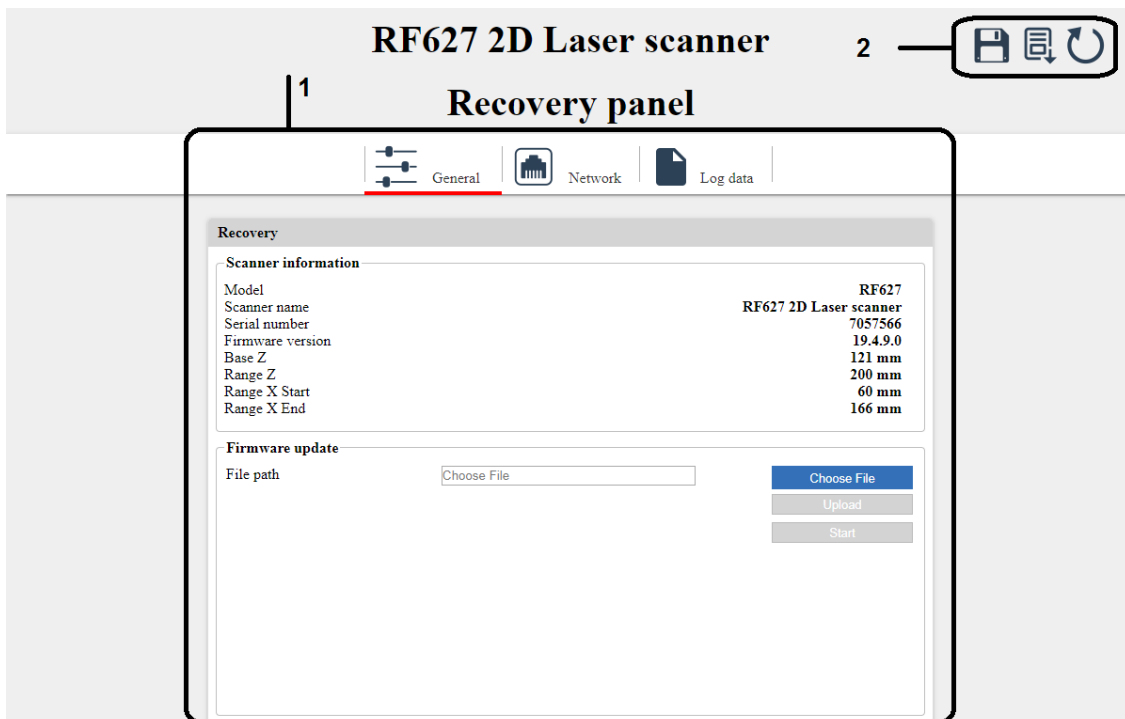

- view general scanner settings;
- update the firmware of the scanner;
- view and, if necessary, change the network settings;
- view the log file.

The WEB page in **Recovery** mode is shown below:



Area 1 contains tabs, switching between which you can view or set the required parameters.

Area 2 contains control buttons:

Button	Name	Description
	Save configuration	Save settings to the flash memory of the scanner.
	Load defaults	Restore the factory settings. Important: It is necessary to reboot the scanner after restoring the factory settings. Click the Restart device button.
	Restart device	Restart the scanner.

28.1. "General" tab

The **General** tab has two sections: **Scanner information** and **Firmware update**.

28.1.1. Scanner information

The **Scanner information** section contains the following information:

- Device ID;
- Scanner name;
- Serial number;
- Firmware version;
- Measurement ranges.

Scanner information

Model	RF627
Scanner name	RF627 2D Laser scanner
Serial number	7057566
Firmware version	19.4.9.0
Base Z	121 mm
Range Z	200 mm
Range X Start	60 mm
Range X End	166 mm

28.1.2. Firmware update

The **Firmware update** tab makes it possible to update the scanner firmware.

Firmware update

File path ✓

Element type	Version	CRC
FIRMWARE	1.1.1.5	OK

The firmware update procedure is described in par. [23.3](#).

28.2. "Network" tab

To configure the network parameters of the scanner, go to the **Network** tab.

Current IP settings

IP address	192.168.1.30
Gateway	192.168.1.1
Subnet mask	255.255.255.0
Service port	50011
HTTP port	80
<input type="button" value="Change"/>	

Parameters:

Parameters	Factory value	Description
IP address	192.168.1.30	IP address of the scanner.
Gateway	192.168.1.1	Gateway address.
Subnet mask	255.255.255.0	Network mask.
Service port	50011	Scanner port number for the service protocol.
HTTP Port	80	Port number for HTTP communication (WEB-page).

In order for the changes to take effect, it is necessary to click the **Change** button.

28.3. "Log data" tab

The **Log data** tab displays information about the scanner operation that can be used to detect errors:



This tab is similar to that described in par. [25](#).

29. Warranty policy

Warranty assurance for Laser Scanners FDRF627 Series – 24 months from the date of shipping; warranty shelf-life – 12 months.

Warranty repair is not provided in the following cases:

- mechanical damage caused by impacts or falling from height,
- damage caused by opening the housing, incorrect connection, or absence of grounding.

30. Technical support

Technical support for issues related to incorrect work of the scanners and to problems with settings is free.

Technical support related to using the scanners is free. This kind of technical support includes consulting about ways to apply the scanner, and training to work with software tools and libraries.

Technical support for software developed by the customer is paid, and includes the possibility to add new features to software.

Technical support contacts:

- E-mail: sales@althen.nl
- Website: www.althensensors.com

31. Revisions

Date	Revision	Description
16.11.2018	1.0.0	Starting document.
28.12.2018	1.0.1	<ol style="list-style-type: none"> 1. Added the ability to manually adjust the laser output power. 2. Added the description of Recovery mode, section 28. 3. Fixed minor inaccuracies in the description.
27.06.2019	1.0.2	<ol style="list-style-type: none"> 1. Added eleven new scanner models with ranges (Z) from 250 to 1165 mm, section 7.2. 2. Added settings that expand the dynamic range of scanners, section 20.1. 3. Added profile filtering functions (median and bilateral filters), section 20.2. 4. Added "Peak selection mode" function, section 20.1.1. 5. Added the ability to include the point brightness values in the profile package, section 19.3. 6. Added the modes for profile accumulation, viewing and saving profiles, building 3D and brightness models, sections 16.2., 20.3. 7. Changed the firmware file format, section 23.3. 8. Fixed minor inaccuracies in the description.